

Tritium for Generation of Carbocations

Maurizio Speranza

Dipartimento di Studi di Chimica e Tecnologia delle Sostanze Biologicamente Attive, Università degli Studi di Roma "La Sapienza",
Piazzale Aldo Moro, 5-00185 Rome, Italy

Received June 16, 1993 (Revised Manuscript Received September 13, 1993)

Contents

I. Introduction	2933
II. The Foundations of the Decay Technique	2934
A. The Ionogenic Process	2934
B. Source of Chemical Excitation in β Decay	2934
C. Mass Spectrometric Studies of the Fragmentation of Decay Ions	2936
III. Outline of the Decay Technique	2937
A. The Need of Multiple Labeling	2938
B. Prevention of Radiolytic Artifacts	2938
C. Experimental Aspects of the Technique	2939
IV. Applications	2940
A. Carbocations from the Decay of Multitritiated Hydrocarbons	2940
1. Existence, Structure, and Isomerization of Carbocations	2940
2. Reactivity of Carbocations toward Organic Compounds	2946
B. Carbocations from the Tritonation of Hydrocarbons by $^3\text{HeT}^+$ Ions	2969
1. Carbocations from the Tritonation of Alkanes	2970
2. Arenium Ions from the Tritonation of Aromatic Compounds	2972
C. Sila-, Oxa-, Azacarbenium Ions from the Decay of Multitritiated Precursors	2975
1. Silicenium Ions	2975
2. Oxenium Ions	2975
3. Nitrenium Ions	2976
V. Concluding Remarks	2977
VI. Acknowledgements	2977
VII. References	2977

I. Introduction

Since their discovery early in this century, carbocations have been the most thoroughly investigated intermediates in organic chemistry. Interest in these charged species is fully justified by their role in a myriad of chemical processes occurring in different physical systems, from interstellar space to petals of a flower. Thus, understanding the role of carbocations in these systems requires the knowledge of their behavior under largely different experimental conditions, from the isolated state to the condensed phase.

The roots of this knowledge, perhaps more than for some other disciplines, rest on methodological development. In the condensed phase, a breakthrough in the understanding of fundamental aspects of carbocation chemistry, such as bonding and solvation, was made possible by the introduction of nonnucleophilic media wherein long-lived cationic transients can be generated and their structure and reactivity investigated by modern spectroscopic techniques.¹ In the gas phase,



Maurizio Speranza was born in Rome in 1945. He received his undergraduate education at the University of Rome "La Sapienza" (1963-1968), as a student of Professor Gabriello Illuminati. From 1969 to 1986 he had been a staff member of the Institute of Nuclear Chemistry of the Research National Council of Italy. During this time he gained postdoctoral experience at the Washington University, St. Louis, MO (1974-1975) and at the Brookhaven National Laboratory, Upton, NY (1980, 1983, and 1984) and taught at the University of Camerino (Mc), Italy (1977-1985). In 1986, he joined the faculty at the University of Camerino as a full professor of General Chemistry, and then he moved first to the University of Tuscia-Viterbo (1987-1990) and then in 1991 to the University of Rome "La Sapienza", where he is presently. His current research interests include structural, kinetic, and mechanistic studies in the area of gas-phase ion chemistry, by mass spectrometric, radiolytic, and nuclear-decay methods, and the fast synthesis of radioactive intermediates.

the rapid technological advances of the last decades provided the materials as well as the sophisticated mass spectrometric instrumentation we take for granted today in the study of ion-molecule reactions.² In their own ambit, the wealth of data collected by each of these advanced methodologies has created the conditions necessary for quantitative predictions on the stability and the reactivity of carbocations in the respective physical environment. When, instead, a comparison is made between solution- and gas-phase ion chemistry models, as emerging from low-pressure mass spectrometric data, one faces so few similarities as to believe erroneously that, in the condensed phase, solvation and ion pairing not only affect the intrinsic reactivity of the ionic species but even their mode of action itself. This misconception issues from severe operational limitations of the performance of purely mass spectrometric approaches, if evaluated by solution-chemistry standards. In fact, apart from the severely restricted pressure range generally accessible and the relative high energy of the ionic reagents, the mass spectrometric study of ion-molecule reactions provides little more than a stoichiometric outline of the process investigated, giving scarce information, if any, on the molecular structure of the ions and the neutral products, the regio- and stereochemistry of the reaction, etc., which rep-

resent essential data, generally accessible in solution. Thereby, deeply felt is the need of implementing the study of the ion chemistry in the gas phase with novel experimental methodologies, wherein these limitations are removed and the high solution-chemistry resolution matched.³

The need of bridging the gap between mass spectrometry and solution by developing experimental methods, allowing investigation of ion-molecule reactions in a wide pressure range from low-pressure gases to dense gases and to liquid and solid systems, has been perceived long ago. In fact, the proposal of exploiting the decay of tritium atoms as the base of an experimental approach for the kinetic and mechanistic study of ionic reactions dates back to 1963 when Cacace⁴ conceived the method today known as the "decay technique". The proposal not only defined the principles and the goals of the technique, but described as well its key experimental features, including the use of multiply labeled precursors, the need and the means of preventing radiolytic artifacts, *etc.*, which are used, without significant changes, in current decay experiments.

A more detailed illustration of the principles and earlier applications of the decay technique to the study of gaseous carbocations followed in 1970, in a review addressing, in particular, the problem of excitation induced in a molecule by the decay of a constituent tritium atom.⁵ The picture of decay-induced molecular excitation remains essentially unchanged, except for the vibrational excitation of the carbocation produced from the decay due to its "wrong" geometry, the so-called "deformation energy" (*vide infra*), uncovered in 1978 by Cacace and Giacomello.⁶

As the structural and mechanistic applications of the decay technique grew in number and sophistication, the subject was repeatedly reviewed,⁷ and a particularly detailed account, covering both fundamental and experimental aspects, as well as the most significant results was published in 1988.⁸

In the decay technique, the ionic species, commonly referred to as the "decay ion" or "nucleogenic ion", originate from the spontaneous nuclear decay of a radioactive atom covalently bonded in a suitable precursor molecule. Since the probability of the nuclear transition in a radioactive atom does not depend upon its physical surroundings, it yields with the same efficiency the same decay species, irrespective of whether the decaying atom is free or bound in a molecule, either in the isolated state or in dense gases or liquids. Besides, the nucleogenic ionic species are generated in a free state, their charge being balanced by that of the departing particle, which is endowed with significant kinetic energy and moves far away from the decay ion by the time of nuclear motions. For this reason, even in condensed media, the nucleogenic ion is initially unsolvated (more precisely, it is in the same solvation state of its neutral precursor) and, in many cases, may react well before an organized solvent shell had time to assemble.

Such unique features make the decay technique the tool of choice for connecting our understanding of the structure and reactivity of free ions in the gas phase and in solution and for establishing a link between experimental data and theoretical predictions, normally referring to isolated species.

The scope of this review article is to outline the foundations and the salient experimental aspects of the decay technique, with special regard to its application to kinetic and mechanistic studies involving free carbocations generated from suitable tritiated precursors. Then, an exhaustive coverage of the most significant achievements reached in this area since the introduction of the technique is presented.

II. The Foundations of the Decay Technique

A. The Ionogenic Process

A knowledge of the primary physical and chemical processes occurring after nuclear decay is essential for a rational understanding of the chemical aftereffects. The reader is referred to any nuclear physics textbook for basic nuclear concepts and to nuclear chemistry reports⁹ for more chemistry-oriented views.

Tritium, ³H, hereafter indicated with the symbol T, has a half-life of 12.26 years, corresponding to a decay rate of ca. 5.5% per year. It transmutes into ³He following emission of an antineutrino $\bar{\nu}$ and of a β^- particle, with a mean energy of 5.6 keV and a maximum energy of 18.6 keV (eq 1).

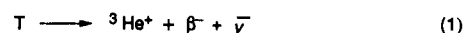

The decay entails the change of the nuclear charge and, therefore, of the chemical identity of the decaying atom, an event which has profound chemical consequences. In addition, the principle of charged conservation requires that the overall charge of the decay fragments must increase by one unit following the emission of the negatively charged β^- particle. In the frequent case in which the decaying T atom is bound to a neutral moiety R, the β^- -transition yields a cationic species R-³He⁺ (eq 2). This latter almost invariably collapses to a carbocation R⁺, if the decaying T atom was originally bonded to a C atom in the neutral precursor.

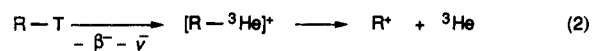

B. Source of Chemical Excitation in β^- Decay

There are several important sources of chemical excitation following β^- decay: (i) change in chemical identity; (ii) the positive charge imparted to the nucleogenic species; (iii) mechanical recoil according to the conservation of momentum; (iv) electronic excitation due to a sudden change of the atomic number; (v) geometry distortion of the rest of the molecule. Usually these effects not only cause the rupture of the bond connecting originally the decaying atom to the rest of the molecule, but also secondary molecular consequences, such as multiple ionization, electronic and vibrational excitation, *etc.*

The most direct and dramatic consequence of the β^- decay is undoubtedly the change of chemical identity undergone by the radioactive atom (i), which drastically affects all its properties, including the ability to form, or maintain, chemical bonds. If the radioactive atom is chemically combined, the change of its atomic number is often sufficient to cause the disruption of the

molecule, particularly when the nuclide formed from the decay is a noble gas atom, *e.g.* ^3He from T. A similarly important role in determining bond rupture after β decay is played by the change in nuclear charge in the nucleogenic species (ii). It follows that, in tritiated molecules, the molecular consequences of tritium decay largely depend on the nature of the atom originally bonded to T. Thus, while the $^3\text{He-H}^+$ ion, if generated in its electronic ground state from β decay of HT, is quite stable and is expected to survive dissociation, the C- ^3He interaction in the nucleogenic cation from β decay of tritiated hydrocarbons is, in the vast majority of cases, purely repulsive and, thus, is expected to dissociate in a time comparable to the bond-vibration period.

The fate of the nucleogenic species from β decay depends as well on the amount of vibrational and electronic excitation imparted by the nuclear transition to the decay ions. These aspects have been the matter of extensive theoretical and experimental work.⁹ Referring first to the decay of an isolated T atom, there are two major causes of excitation, *i.e.* the momentum transfer to the $^3\text{He}^+$ decay ion from the emitted β^- particle and the antineutrino $\bar{\nu}$ (iii), and the "shaking" of the electron cloud due to the sudden increase of the nuclear charge (iv). Several other extranuclear processes, such as vacancy cascades, internal conversion of internal bremsstrahlung, internal pair conversion of internal bremsstrahlung, capture of the β^- particle in an electron shell of the nucleogenic ion, *etc.*, which often accompany the ejection of the β^- particle, and may represent additional sources of excitation and multiple ionization in the nuclear transition of β emitters other than T, are insignificant in T β decay.

The recoil energy of the decay ion is given by the following equation:

$$E_R = \frac{m_0 (E_\beta + 1.02)}{0.51} \cdot \frac{E_\beta}{2M} \quad (3)$$

which can be written

$$E_R (\text{eV}) = \frac{536}{M} [E_\beta^2 + 1.02 E_\beta] \quad (4)$$

where E_β is the energy of the β^- particle in million electron volts (MeV), m_0 and M are the rest mass of the electron and of the recoil atom in atomic mass units (amu), respectively. The mechanical recoil due to the emission of the antineutrino $\bar{\nu}$ is negligible in most cases. It should be emphasized that because of the continuous character of the β^- spectrum, the recoiling atoms also have a continuous distribution in energy. The exact calculation of the recoil energy spectrum requires the knowledge of the β^- particle-antineutrino angular correlation. The mean recoil energy can be estimated from the β^- spectrum if no angular correlation between the β^- particle and the antineutrino is assumed.¹⁰ For instance, the maximum recoil energy of the $^3\text{He}^+$ ion from the β decay of T is 3.6 eV, but actually the recoil energies are continuously distributed from 0 to 3.6 eV. The mean recoil energy is less than 1 eV, *i.e.* is smaller than most of the chemical bond energies (2–6 eV).

It should be emphasized that eqs 3 and 4 only hold for free atoms. If the decay atom is bonded chemically in a molecule only a fraction of the recoil energy becomes

available for bond rupture, the rest of it appearing as translational energy of the whole molecule. The internal energy available for bond breaking, E_{int} is

$$E_{\text{int}} = E_R \frac{R}{R + M} \quad (5)$$

where M and R are atomic weights of the recoil atom and the rest of the molecule, respectively. This equation, derived for diatomic molecules,¹¹ can also be used for larger molecules. It follows from eq 5, for instance, that the recoil energy of at least 3.7 eV would be required to break the $^3\text{He-H}^+$ bond (estimated as equal to that of $^4\text{He-H}^+ = 1.85$ eV)¹² from β decay of HT. Since this value exceeds the maximum recoil energy of the $^3\text{He}^+$ ion from β decay of T (=3.6 eV), it is expected that no fragmentation should occur in $^3\text{He-H}^+$ from the recoil associated to the nuclear transition. For larger molecules, however, this conclusion is not warranted any longer. In fact, a recoil energy of only 1.1 eV would be sufficient to break a $^3\text{He-C}$ bond (*ca.* 1 eV) in a decay ion of mass 28, like $^3\text{He-C}\equiv\text{C-H}^+$ (see part i of section IV.A.1).¹³ It can be seen from the β spectrum of T that less than one half of recoil ^3He atoms fulfils this requirement. For larger molecules it appears from statistical considerations that the probability of localization of a sufficient amount of energy on the bond holding the decay atom decreases with the complexity of the molecule and consequently the retention, *i.e.* the probability that the bond will not be broken, is higher. However, for tritiated hydrocarbons, other than alkynes, the problem of the effects of the mechanical recoil associated to the nuclear decay of T upon the fragmentation of the C- ^3He bond does not matter owing to the repulsive character of the C-He interaction.

In addition to recoil, electronic excitation or even additional ionization of the nucleogenic species may result from the β^- particle emission, due to the non-adiabatic nature of the decay process.⁹ The sudden change of the nuclear charge, caused by the emission of a β^- particle from the nucleus, perturbs the electronic shells of the atom (electron "shaking"). The total energy released in the decay event is shared among the nucleogenic ion, the antineutrino, and the β^- particle, which traverses the atom in a time $<10^{-16}$ s, far too short to allow the adiabatic readjustment of the electron cloud to the increased nuclear field (Table 1).

As a consequence, a fraction of the energy that in an ideal, adiabatic transition would be carried away by the outgoing β^- particle can be converted into electronic excitation of the $^3\text{He}^+$ ion. Another way of looking at the shaking effects, perhaps more familiar to the chemist, proceeds from the realization that the 1s orbitals of the T atom and of the $^3\text{He}^+$ ion do not overlap exactly. As a consequence, following the sudden nuclear change undergone by the atom, its electron has a finite probability to occupy some $^3\text{He}^+$ orbital other than the ground-state (1s) one, *i.e.* an electronically excited nucleogenic ion is formed.

The very simple species involved and the applicability of the sudden perturbation approach have allowed an accurate theoretical analysis of the excitation mechanism as early as 1941. In that year, Midgal¹⁴ showed that the probability of the decay-promoted transition from the 1s electronic ground state of tritium to a final

Table 1. Time Scale of Events in Ionogenic Processes

time (s)	event
10 ⁻¹⁸	1-MeV electron traverses molecule
10 ⁻¹⁷	lifetime of an electron vacancy
	1-MeV α particle traverses molecule
10 ⁻¹⁶	5-eV electron traverses molecule
	excitation or ionization by charged particle
10 ⁻¹⁵	Auger effect
	charging time of vacancy cascades
10 ⁻¹⁴	autoionization of superexcited states
	C- ³ He ⁺ bond breaking (β decay)
	transfer of energy to vibrational modes
10 ⁻¹³	molecular vibration
	ion-molecule collisions in condensed phase
10 ⁻¹²	molecular collisions in condensed phase
	internal conversion to lowest excited state in polyatomic molecule
10 ⁻¹¹	electron is solvated in polar media
10 ⁻⁹	ion-molecule collisions in gases at 1 atm
	molecular collisions in gases at 1 atm
10 ⁻⁸	fluorescence
10 ⁻⁶	lifetime of metastable ions
10 ⁻⁵	scavenging of radicals
10 ⁻³	phosphorescence

electronic state of the ³He⁺ decay ion, characterized by the n and l quantum numbers, can be computed from the square of the overlap integral:

$$P[1s(T) \rightarrow n,l(^3\text{He}^+)] = \left| \int \Psi_{n,l}^* \Psi_{1s} d\tau \right|^2 \quad (6)$$

where $d\tau$ is the volume element. The sum of the probabilities of the transitions to all bound states of the electron converges to a definite limit that, subtracted from the unity, gives the probability of ejection of the electron into the continuum, namely, of formation of the doubly charged ³He²⁺ ion. In the decay of isolated tritium atoms, *ca.* 70% of the transitions lead to ground-state ³He⁺ ions, *ca.* 25% to the first excited level (40.5 eV), *ca.* 2.5% to higher excited states, and *ca.* 2.5% to the formation of ³He²⁺ ions.

Subsequent studies have shown that the results of Migdal's calculations were essentially correct, independent support being provided by theoretical and experimental investigations on the decay of chemically bound T atoms (*vide infra*), which excluded other mechanisms of electronic excitation operative in heavier nuclei, *e.g.* direct collision of the outgoing β^- particle with orbital electrons, vacancy cascades, and conversion of internal bremsstrahlung,⁷ since comparatively insignificant (probability < 10⁻⁶ per decay).

An additional source of excitation, of special interest in structural and kinetic applications of the decay technique, may arise from the fact that the decay ions are formed in a "wrong" geometry, reminiscent of their neutral precursors (*v.*).¹⁶ Consider, as a typical example, the decay of a tritiated methane:

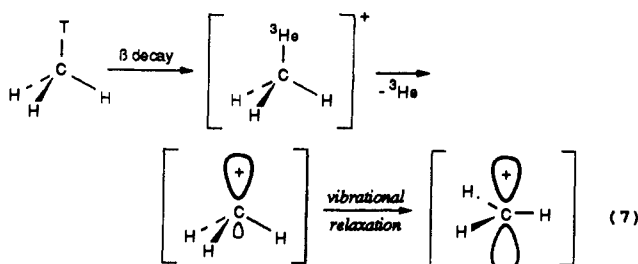

Relaxation from the pyramidal structure of the nucleogenic methyl cation, reminiscent of that of methane, to the planar geometry of the ground-state ion releases an amount of energy corresponding to the stability difference between the two structures. Although a fraction of such "deformation" energy can be carried away by the outgoing ³He atom, a large fraction will be retained as internal energy of the nucleogenic ion, causing its vibrational and rotational excitation. Theoretical calculations show that the deformation energy of the decay ions is far from trivial, amounting to *ca.* 30 kcal mol⁻¹ in CH₃⁺ from tritiated methane.¹⁵ In C₂H₃⁺ ions from C₂H₃T, an upper limit of the excess internal energy of 50 kcal mol⁻¹ can be similarly calculated,¹⁶ whereas that of C₆H₅⁺ from tritiated benzene has been calculated to range from 25 to 32 kcal mol⁻¹.¹⁷

Vibrational excitation of the decay ions present at the same time a problem and an opportunity. On the one hand, the excited ions must be quenched, *e.g.* by collision with inert molecules, before being used as a reactant in kinetic studies, where a thermal energy distribution is required. On the other hand, vibrational excitation turns out of advantage in structural studies, allowing intramolecular rearrangements whose direction and rate provide valuable information on the relative stability of isomeric ions and on the barriers to their interconversion.

C. Mass Spectrometric Studies of the Fragmentation of Decay Ions

The experimental verification of the theoretical predictions concerning the decay-induced fragmentation pattern of gaseous tritiated molecules has been carried out using *ad hoc* designed, or modified, mass spectrometers. The forms of the early apparatus employed, while differing in several significant details, may all be regarded as modified mass spectrometers, where the ions to be analyzed are not produced, as usual, through the bombardment of a neutral gas with energetic electrons but arise directly from the β decay of a gaseous tritiated precursor. A scheme of the apparatus used by Wexler,¹⁸ which may be considered as representative of this class of instruments, sometimes called "charge" mass spectrometers, is illustrated in Figure 1.

The tritiated gas to be studied enters from the capillary leak (A) into the large chamber (B), wherein the pressure of the gas is maintained between 10⁻⁴ and 3 × 10⁻⁶ Torr by an adequate pumping system. During their residence time in the chamber, a small fraction of the tritiated molecules decays, yielding positively charged nucleogenic ions, which are accelerated and focused by an array of electrodes (C), maintained at suitable potentials. The decay ions formed within the source are conveyed toward the entrance slit of the magnetic analyzer of the mass spectrometer (D) and leave the source before having a chance to collide with the molecules of the neutral precursor. A large diffusion pump (E) and a cold baffle (F) are used to eliminate the bulk of the tritiated gas effusing from the ionization chamber, while an additional diffusion pump (G) is attached to the detector compartment. The strong differential pumping system is necessary to prevent

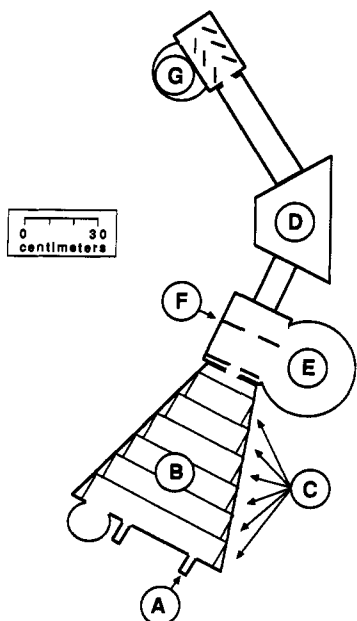

Figure 1. Charge mass spectrometer for the study of unimolecular fragmentation of nucleogenic ions (see text).

the tritiated gas from diffusing into the detector chamber and decaying there, thus producing an intolerably high background. Other operational conditions required to obtain meaningful measurements are the use of ionization chambers of sufficiently high volume and tritiated gases of sufficiently high specific activity to ensure an adequate rate of formation of the decay ions in the absence of appreciable ionization of the neutral precursor by the particles and secondary ion-molecule reactions.¹⁹ The design of the "charge" mass spectrometers has undergone significant changes over the years. Quadrupole mass filters have replaced magnetic sector analyzers,²⁰ and, perhaps more significantly, commercial ion cyclotron resonance (ICR) spectrometers, fitted with time averaging computers, have been found perfectly adequate to measure decay-induced fragmentation pattern without requiring special modification.²¹

The mass spectrometric results are, in general, fairly consistent with those of theoretical calculations, showing, however, that the latter tend to overestimate the excitation associated to the β transition. Accordingly, the mass spectrometric results can be summarized as follows:

(i) The decay of TX molecules ($X = H, T$) gives abundances of undissociated nucleogenic ions ${}^3\text{HeX}^+$ ranging from 89.5 to 94.5%, minor fragments being ${}^3\text{He}^+$, X^+ , and ${}^3\text{He}^{2+}$.²²

(ii) The decay of tritiated hydrocarbons is invariably followed by loss of neutral ${}^3\text{He}$. A high fraction (*ca.* 80%) of the nucleogenic carbocations, remarkably independent of their structure, survives further fragmentation during the long time lag (10^{-4} to 10^{-5} s) between their formation in the ionization chamber of the "charge" mass spectrometer and their detection. Typical yields of stable nucleogenic ions are listed in Table 2.

(iii) The organic ions which dissociate further may undergo extensive fragmentation, different from that promoted by electron impact. Thus, the CH_3T decay yields, together with a 82.4% abundance of stable CH_3^+

Table 2. Abundances of Major Daughter Ions from the Decay of Isolated Tritiated Molecules

molecule	daughter ion	abundance (%)	ref
CH_3T	CH_3^+	82	23
$\text{C}_2\text{H}_5\text{T}$	C_2H_5^+	80	24
$\text{CH}_3\text{CH}_2\text{CH}_2\text{T}$	C_3H_7^+	41	25
$\text{CH}_3\text{CHTCH}_3$	C_3H_7^+	56	25
$\text{C}_6\text{H}_5\text{T}$	C_6H_5^+	72	26
<i>o</i> - $\text{CH}_3\text{C}_6\text{H}_4\text{T}$	C_7H_7^+	78	25
<i>m</i> - $\text{CH}_3\text{C}_6\text{H}_4\text{T}$	C_7H_7^+	79	25
<i>p</i> - $\text{CH}_3\text{C}_6\text{H}_4\text{T}$	C_7H_7^+	76	25
$\text{C}_6\text{H}_5\text{CH}_2\text{T}$	C_7H_7^+	79	25
<i>c</i> - $\text{C}_4\text{H}_7\text{T}$	C_4H_7^+	80	21
<i>c</i> - $\text{C}_6\text{H}_9\text{T}$	C_6H_9^+	75	21
CH_2IT	CH_2I^+	56	27

ions, the following charged fragments: CH_2^+ (4.9%), CH^+ (4.0%), C^+ (4.9%), and H^+ (2.4%).²³

In conclusion, the mass spectrometric studies largely support the theoretical predictions illustrated in the previous section concerning several important points:

(i) The decay of isolated, hydrogen-like molecule TX gives high yields (over 90%) of the ${}^3\text{HeX}^+$ nucleogenic ions, in their electronic ground state, containing a moderate excess of vibrational energy. Such ions, in particular ${}^3\text{HeT}^+$ ($X = T$), are used as extremely powerful protonating agent in gas-phase ion chemistry (see section IV.B).

(ii) The change of chemical identity undergone by the T atom in tritiated hydrocarbon molecules is the most significant cause of molecular fragmentation of the primary nucleogenic species, yielding ${}^3\text{He}$ and the corresponding carbocations. The major source of excitation in these latter ions is their deformation energy, whose amount depends on the specific molecule concerned.

(iii) The theoretical estimate that most (over 80%) of the nucleogenic ions are formed in their electronic ground state is supported by the experimental evidence.

III. Outline of the Decay Technique

The general principle underlying the decay approach is that the nuclear transition of a T atom covalently bound in a specific position of a hydrocarbon molecule will produce, independently of the environment, a carbocation of known structure and energy, whose reactions can be studied in gaseous systems at any desired pressure, or even in the liquid or solid phase. In structural and mechanistic applications, the nucleogenic carbocations are allowed to interact with suitable nucleophiles. The neutral end products from the ion-molecule reactions triggered by the nuclear event, hereafter referred to as "decay products", can be isolated and subjected to structural analysis.

The nature and the rate of the nuclear event responsible for the formation of the nucleogenic carbocations introduce several important problems, which one must be aware of for a correct application of the decay technique. The first problem arises from the extremely small rate of formation of the decay ions, since only *ca.* 0.5% of the tritiated precursor undergoes β decay in 1 month. Another problem arises in connection with the fact that decay of the T atom in a tritiated molecule introduces into the system, together with the nucleogenic carbocation, a β^- particle with a mean energy of 5.6 keV, which is absorbed by the

gaseous or liquid system, giving rise *inter alia* to radiolytically generated ("radiolytic") ions.

A. The Need of Multiple Labeling

To minimize the extent of unwanted radiolytic processes, the activity of the tritiated precursors used in the decay experiments must be kept as low as possible, typically below 10 mCi per mol. As a consequence, the number of the decay ions, hence the amount of their neutral decay products formed in any reasonable period of time, is comparatively quite small. Even in a storage period as long as 1 year, the decay of 10 mCi of a monotruncated precursor in 1 mol of an inactive gas ("bulk gas") yields only about 10^{16} nucleogenic ions. Under the favorable assumption that all ions give a single end product, its concentration would be of the order of only a few parts per billion (ppb), posing formidable problems even to very advanced, highly sophisticated analytical methodologies. Even more seriously, the decay products would be swamped by those arising from the radiolysis of the bulk gas, promoted by the β^- particles of tritium, since each decay event produces, together with a single nucleogenic ion, over 200 radiolytic ions.

The above difficulties were solved by the use of precursors containing at least two T atoms in the same molecule,⁴ whose decay yields nucleogenic ions still containing radioactive atoms acting as a label. Multiply tritiated precursors serve three useful purposes. First, the analysis of the labeled decay products can easily be accomplished by sensitive radiometric techniques, *e.g.* radio gas-liquid chromatography (GLC) or high-performance liquid chromatography (HPLC), capable of detecting an extremely small number of tritiated molecules. Referring to the previous example, 10^{16} molecules of decay products, each containing one T atom, have the respectable activity of about 0.5 mCi, exceeding the detection limit by a factor of at least 10^7 . Second, the decay ions from a multiply tritiated precursor are necessarily labeled, which is not the case of the radiolytic ions and, therefore, of their neutral products. Thus, multiple labeling provides a way of distinguishing the nucleogenic products from the interfering radiolytic ones. Finally, in those cases in which the position of the tritium atoms in the molecule of the precursor is precisely known, measuring the intramolecular tritium distribution in the products can provide mechanistic and structural insight, as illustrated in the example reported in part f of section IV.A.1.

The synthesis of precursors containing at least two tritium atoms within the same molecule is far from easy, and probably represents the most serious experimentally difficulty associated with the use of the decay ions. Especially developed synthetic, purification, and analytical procedures must be used for the preparation of chemically, radiochemically, and isotopically pure multilabeled precursors, such as CT₄, reaching a specific activity in excess of 10^5 Ci per mol, which must be obtained in the carrier-free state, before dilution with a very large excess of inactive material to avoid its rapid self-radiolytic decomposition.

The random nature of the radioactive decay of T imposes an additional experimental constraint. In order to obtain nucleogenic ions having a single structure and charge location, the radioactive atoms must be

contained in equivalent positions within the molecule of the multitruncated precursor. When this condition is prevented by the particular nature of the tritiated neutral precursor, *e.g.* *p*-T-toluene, one is forced to deal with several nucleogenic ions, including that of interest (*e.g.* the *p*-tolylum ion), formed from the β decay of one of the T atoms (including that at the *para* position) randomly distributed in ring-multitruncated toluene (see part g of section IV.A.1).

B. Prevention of Radiolytic Artifacts

As mentioned before, it is necessary to guard against the possibility that the β^- particle from the decay of a given tritiated precursor can affect, directly or otherwise, another tritiated molecule. It must be recalled, in fact, that the decay technique makes use of the same experimental methodology on which is based the Wilzbach process (as it is called, after its inventor)²⁸ for introducing tritium into organic compounds, namely by simple exposure of the compound of interest to Curie quantities of tritium gas. Under the Wilzbach conditions, tritiation of the compound in question by the tritiated nucleogenic ions from β decay of T₂ (mainly ³HeT⁺) accounts only for a fraction, and usually a minor one, of the tritiated product. Here, radiolytic mechanisms contribute to a much greater extent. These can be of various kinds, and they may contribute to different extents in different cases. On the one hand, the energetic β^- particle emitted by a tritium nucleus of a T₂ molecule may interact with a second T₂ molecule producing reactive tritiated species, such as tritium atoms and excited or ionized tritium molecules (T₂⁺). On the other hand, it may excite or ionize the organic molecules of the sample, whose charge may in turn be transferred to those with the lowest ionization potential (charge sinks). Excited and ionized molecules can eventually react with the neutral species present, including T₂ molecules, thus producing radiolytic tritiated products. The labeled products, independently of their origin (either nucleogenic or radiolytic), may be further destroyed or altered by radiolysis during the Wilzbach storage period (hours or days). The same mechanism can be operative as well if the source of β^- particles is a tritiated organic molecule, instead of T₂.

An effective way of dealing with the problem is based on the fact that *all* nucleogenic ions from multitruncated precursors, the species of interest in the decay technique, are necessarily labeled, whereas the parasitic radiolytic decomposition affects *both* tritiated and unlabeled molecules. Consider, as a simplified example, the decay of a multitruncated precursor in a large excess of unlabeled, but otherwise identical, molecules. According to the decay law, the formation rate of the nucleogenic ions, and eventually of their tritiated products, is proportional to the tritium activity in the system, *i.e.* to the labeled precursor concentration (curve a of Figure 2). On the contrary, the rate of formation of the tritiated radiolytic ions, and, thus, of their products depends on the radiation dose absorbed by the tritiated molecules, which in turn is a function of both the intensity of the β radiation emitted by the decaying tritiated precursor (proportional to its concentration) and the molar fraction of labeled precursor itself. As a result, the formation rate of the tritiated radiolytic products is approximately proportional to

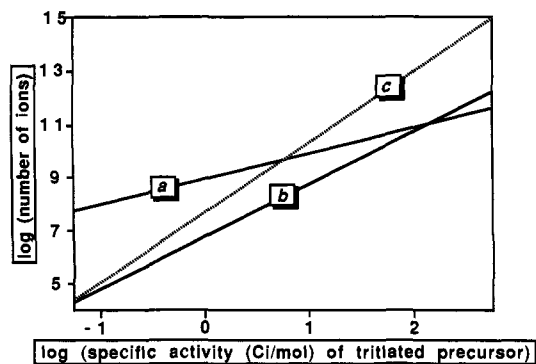

Figure 2. Correlation between the number of nucleogenic (a) and radiolytic (b and c) ions and the specific activity of their tritiated precursor (see text).

the square of the concentration of the tritiated compound (curve b of Figure 2). Therefore, decreasing the molar activity of the labeled starting compound depresses the formation rate of the nucleogenic products to a smaller extent than of the tritiated radiogenic products, whose yields become comparatively negligible at sufficiently low activity levels.

In actual decay experiments in which the tritiated precursor is, in general, chemically different from the bulk gas, the assumption that radiolytic processes are entirely indiscriminate is questionable owing to the possible occurrence of selective charge and energy transfers, selective ionic and radical reactions, *etc.* Thus, for instance, diluting the multitritiated organic precursors with a bulk gas having a relatively high ionization potential (*e.g.* Kr, Xe, N₂, *etc.*) is self-defeating, since the labeled organic compounds would represent anyhow the charge sink of the decay system. Furthermore, in these gaseous media, there is a high probability that most radiolytic radicals and ions will survive until interacting with their labeled organic precursor, yielding eventually tritiated radiolytic products, with a relative efficiency depending on the composition of the gaseous mixture. Under such circumstances, the slope of curve b of Figure 2, describing the concentration of the tritiated radiolytic products as a function of the molar activity of the labeled precursor, is further increased (curve c of Figure 2) so as to cross curve a at relatively low precursor concentrations.

These theoretical considerations conform to the experimental evidence, showing that decreasing the tritium activity in the gas phase is indeed an effective way of reducing to negligible levels the radiolytic route to tritiated products. In fact, it has been shown^{4,29} that the occurrence of radiolytic artifacts can easily be detected carrying out a "blank" run under exactly the same set of conditions prevailing in the actual decay experiment, except for the fact that the multitritiated precursor is replaced by the same activity of the corresponding singly tritiated compound. Since the decay of the latter gives *unlabeled* nucleogenic ions, any tritiated products formed must necessarily arise from radiolytic pathways, whose role can thus exactly be weighed. The evidence from such "blank" runs shows that, except in a few systems prone to radiation-induced chain reactions, the yields of tritiated radiolytic products are negligible in comparison with those of decay products when the tritium activity does not exceed about 100 mCi per mol of bulk gas.

Unfortunately, the possibility of radiolytic artifacts, which has been repeatedly stressed,^{5,28,29} has not been entirely perceived by the generality of the workers, some of them having occasionally used large activities of tritiated precursors, sometimes as high as several hundreds Curies per mol,³⁰ now and then diluted in high-ionization potential gases,³¹ in the attempt of reducing the duration of the experiments and of easing the analytical procedures. The results of these decay experiments, that are to be used with extreme caution owing to the artifacts from the incursion of radiolytic processes, will be critically surveyed in section IV.

C. Experimental Aspects of the Technique

Having dealt with the principles and salient features of the decay technique, we can now proceed to examine the general outline of a typical application to structural and mechanistic problems in the realm of carbocation chemistry in both gas phase and solution. According to the previous considerations, the major steps involved can be itemized as follows:

(i) Preparation of a monotritiated precursor of the carbocation of interest and mass spectrometric study of its decay-induced fragmentation pattern.

(ii) Synthesis of the multitritiated precursor, its purification, and its characterization by spectroscopic or by chemical analysis, in order to establish the isotopic composition and the intramolecular tritium distribution.

(iii) Preparation and storage of the gaseous or liquid decay samples.

(iv) Experimentation with "blank" runs carried out under the same conditions as the planned decay experiments, except for the use of a monotritiated precursor, to verify the absence of radiolytic artifacts.

(v) Analysis of the tritiated decay products by radiochromatographic techniques (radio-HPLC, radio-GLC, *etc.*).

(vi) Isolation of the labeled products by preparative chromatography, following addition of the corresponding inactive carriers, and application of chemical derivatization and/or degradation techniques, aimed at measuring the intramolecular distribution of tritium.

The second step is undoubtedly the most demanding. In fact, although the activity of the precursor recommended for the decay experiments is as low as compatible with the detection limit of the radiochromatographic techniques adopted for the analysis of the decay products (<1 mCi), introduction of two or more tritium atoms into the same molecule dictates that isotopically pure tritiated reactant be used.

The starting reagent is generally molecular tritium itself, T₂, which is commercially available in a state of high isotopic purity and is unaffected by self-radiolysis. All other conceivable intermediates undergo rapid decomposition and must be prepared immediately before use. Molecular T₂ is used directly (for instance, in the preparation of multitritiated alkanes from catalytic reduction of the corresponding unsaturated compounds) or is converted to T₂O, which is used in a variety of synthetic approaches (for instance, reactions with metallic carbides, Grignard reagents, isotopic exchange, *etc.*). Given the specific activity of T₂, 58 200 Ci mol⁻¹, even preparative procedures scaled down to the limit of experimental feasibility require large

activities, especially in the initial steps of the synthetic sequence. An additional constraint is posed by the random nature of the radioactive decay, which requires introducing the T atoms in equivalent positions of the precursors molecule to obtain nucleogenic ions of a single structure and charge location.

In principle, one of the most convenient ways to overcome the formidable problems associated with the synthesis of high specific activity, multitritiated organic precursors required for chemical or biological application is the nuclear decay method itself. For instance, the decay of CT_4 is known to give, irrespective of the environment, nearly quantitative (>82%; Table 2) yields of CT_3^+ , whose subsequent attack on practically all nucleophiles leads to the formation of multitritiated derivatives, which generally retain the radioactive atom exclusively in the CT_3 group. In spite of the low decay rate (ca. 0.5% per month), this synthetic approach can provide within reasonable periods of time quite respectable activities of multiply tritiated products, largely sufficient for most applications, provided that sufficiently high activities of the starting CT_4 precursor are used. As an example, 2.8 mCi (86.1%) of methanol, labeled exclusively in the methyl group, were obtained by allowing multitritiated methane (0.6 Ci) to decay for 14.5 days in water.³² Another example is afforded by the simultaneous preparation of multitritiated methyl (4.4 mCi, 47%) and ethyl bromide (2.3 mCi, 24%) from the decay of multitritiated methane in a $HBr/CH_4/O_2$ 600:137:10 Torr mixture for 43 days at room temperature.³² One-step simultaneous preparation of multitritiated 3-methyl- and 2-methylfuran was attained by allowing multitritiated methane to decay in gaseous furan (150 Torr) for 30 days at 100 °C.³³ By similar procedures, it has been possible to obtain various methyl derivatives of thymine and uracil, labeled at the methyl group in appreciable radiochemical yields, by simple exposure of the solid starting compounds to free CT_3^+ cations, produced by β decay of multitritiated methane.³⁴ Decay-induced incorporation of tritium from T_2 into thymidine and deoxyuridine has been carried out in aqueous solutions as well.³⁵

A number of labeled elementoorganic onium cations of VA–VIIA group elements have been prepared in good radiochemical yields by attack of nucleogenic tritiated benzene, on the corresponding elementoorganic compounds in liquid phase.³⁶ Similarly, tritiated isobutene, styrene, and vinyl ethyl ether polymers of molecular weight ranging from 10^5 to 10^7 and specific activity of several hundreds Curies per gram were obtained from nuclear decay of multitritiated precursors in the presence of unlabeled monomer molecules.³⁷

Remarkable advantages of the decay synthesis over the conventional procedures are the following: (i) in some instances, it is possible to obtain multitritiated products in an essentially carrier-free state; (ii) their continuous buildup makes the procedure a convenient and long-lasting source of the desired multilabeled material; (iii) after the decay synthesis, the bulk of the undecayed, multitritiated precursor (e.g. CT_4) can be recovered virtually unchanged from the reaction mixture.

In any case, irrespective of the synthetic procedure adopted, multitritiated organic compounds are susceptible to self-radiolytic decomposition and must

undergo rapid purification, followed by dilution with appropriate organic substrates, immediately before their use as natural precursors of the nucleogenic tritiated carbocations of interest.

IV. Applications

In this section, a survey is reported of the most significant achievements in carbocation chemistry obtained by the application of the decay technique, since its first introduction in 1963.⁴

The study has been mostly carried out by two research groups and has been focused essentially in the generation, structural characterization, and the evaluation of the reactivity features of a variety of carbocations in both gaseous and condensed phase.

A first set of investigations has been mainly addressed to the structural characterization of saturated and unsaturated carbocations and to the study of their isomerization and fragmentation processes. To this aim, the labeled cations of interest have been obtained from the decay of the corresponding multitritiated hydrocarbons: methyl ions from CT_4 ,³⁸ ethyl ions from 1,2- T_2 -ethane,³⁹ an equimolar mixture of 1- and 2-propyl ions from 1,2- T_2 -propane,⁴⁰ 1-butyl ions from 1,4- T_2 -butane,⁴¹ cyclobutyl ions from multitritiated cyclobutane,⁴² cyclopentyl ions from 1,2- T_2 -cyclopentane,^{20,43} cyclohexyl ions from multitritiated cyclohexane,⁴⁴ benzyl ions from side-chain multilabeled toluene,⁴⁵ *p*-T-phenylium ions from 1,4- T_2 -benzene,⁴⁶ isomeric tolylium ions from ring-multitritiated toluene,⁴⁵ vinyl ions from multitritiated ethene,⁴⁷ an equimolar mixture of α - and β -T-phenylvinyl cations from 1,2- T_2 -styrene,⁴⁸ and $TC\equiv CC_6H_4C\equiv C^+$ from $TC\equiv CC_6H_4C\equiv CT$.⁴⁹ The reactivity of these carbocations has been investigated over a wide range of experimental conditions (from the dilute gas state to the condensed phase) in a large variety of systems, including sometimes the corresponding hydrocarbons as well as various families of σ -, π -, and *n*-type bases.

In a second set of investigations, carbocations have been generated by tritination of a variety of σ - and π -type substrates by the $^3HeT^+$ ions, which is an exceedingly powerful Brønsted acid conveniently obtained from the decay of T_2 . In this way, otherwise inaccessible informations on the structure, the isomerization, and the reactivity of the corresponding tritinated compounds can be achieved, unaffected by the complicating environmental factors such as solvation and ion pairing, encountered in solution chemistry.

A. Carbocations from the Decay of Multitritiated Hydrocarbons

The study of the carbocations generated in the β decay of tritiated hydrocarbons turned essentially in two different directions, the first, in which the emphasis is mostly placed on the investigation of the structure, the electronic configuration, and the isomerization of a given carbocation, and the second, wherein these aspects are already well assessed and the interest is rather focused on the reactivity of the carbocation with selected substrates.

1. Existence, Structure, and Isomerization of Carbocations

a. Propyl Cations. As mentioned in part C of section II, "charge" mass spectrometric investigations

have shown that the β decay of a tritiated hydrocarbon, RT, gives high abundances (70 to 80%) of the nucleogenic ion R^+ , irrespective of the position of the label (Table 2). The decay of tritiated propanes represents however a conspicuous exception, since the abundance of $C_3H_7^+$ ions is abnormally low and different from 1-T-propane (56%) and 2-T-propane (41%).²⁵ The discrepancy is particularly distressing, in that the theoretical models of the decay-induced fragmentation predict that a high fraction (>80%) of the nucleogenic ions is formed with very little, or no excess internal energy, and should survived indissociated. Since the propyl ions formed from the nuclear decay are born in a geometric structure reminiscent of that of the propane precursor and different from the ground-state configuration of the $C_3H_7^+$ species, a reasonable explanation of the above anomaly is that the "deformation energy" of the nucleogenic propyl cations (part B of section II) could promote their unimolecular decomposition to $C_3H_5^+ + H_2$, which is known to involve an activation energy of ca. 41 kcal mol⁻¹.^{50,51} In order to clarify the issue, multitritiated propane⁵² was allowed to decay in the presence of gaseous arenes, *i.e.* benzene and toluene, at pressures up to 400 Torr, in order to ensure a fast quenching of the excited nucleogenic ions and their ionic derivatives.⁵³ The reaction products were predominantly (70–75%) the corresponding *n*-propylated and isopropylated arenes (yield ratio = ca. 1:6), without their allylated counterparts. The results confirm that unimolecular dissociation of "deformed" nucleogenic $C_3H_7^+$ ions into $C_3H_5^+$ and H_2 is the cause of the abnormally low abundances of the $C_3H_7^+$ species measured at low pressures in the charge mass spectrometer, thus removing the disturbing anomaly and supporting the validity of the current theoretical models.

b. Butyl Cations. One of the most eminent advantages of the decay technique is the possibility to generate a carbocation of defined structure and energy in any media regardless of their composition and aggregation state (section I). This potentiality has been extensively applied in a study of the isomerization of 1-butyl cation as a function of its lifetime and energy content. Thus, 1,4-T₂-butane⁴¹ was allowed to decay in the presence of several acceptors, *i.e.* benzene or CO/C₂H₅OH, in both gaseous (at over 15 atm) and condensed phase, in order to progressively induced a rapid collisional quenching of the ionic species involved and reduce their lifetime. In gaseous benzene at room temperature, high yields (>70%) of isomeric butylbenzenes are formed, with the *sec*-butyl benzene isomer by far prevailing (85%) over the *n* (3%) and *tert*-butyl ones (14%). In liquid benzene at room temperature and in solid benzene at -196 °C, a different distribution is observed, characterized by the complete absence of *tert*-butylbenzene and by a *sec*-to-*n*-butylbenzene yield ratio not exceeding 10.⁵⁴ In gaseous benzene at 150 °C and at 0.9–3.0 atm, a *n*-/*sec*-/*tert*-butylbenzene yield ratio of 2:95:3 is observed, which is essentially independent of the system pressure.⁵⁵ The results are consistent with a nucleogenic *n*-butyl cation isomerizing in less than 10⁻¹³ s into *sec*-butyl cations. This is accounted for by a "deformation energy" associated with the nucleogenic *n*-butyl ion largely exceeding the limited energy barrier for 1,2-hydride shift. The observation

of ca. 15% of *tert*-butylbenzene in gaseous benzene at room temperature is in harmony with the substantial activation energy (ca. 18 kcal mol⁻¹)⁵⁶ involved in the isomerization of *sec* to *tert*-butyl ion. Accordingly, increasing the benzene pressure (up to 3 atm at 150 °C) leads to a significant reduction of the relative yield of *tert*-butylbenzene (ca. 3%), as a result of the reduced lifetime of the *sec*-butyl ion. A similar picture is obtained by replacing benzene with a CO/C₂H₅OH gaseous mixture (from 0.9 to over 15 atm of total pressure), as an acceptor of the isomeric butyl cations (eq 8).⁵⁷

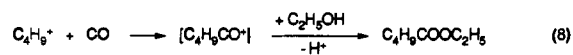

In these systems, virtually the only labeled product from eq 8 is the ethyl ester of α -methylbutyric acid, thus pointing to the complete isomerization of the primary *n*-butyl cation to the secondary isomer in ca. 10⁻¹³ s, and the complete trapping of the latter prior to its further isomerization to *tert*-butyl cation. This excludes the conceivable hypothesis that, in the benzene systems, the distribution of the butylbenzene products were due not only to the isomerization of the *n*-butyl cations prior to the condensation to benzene but also to the isomerization of the butylated arenium ions from attack of butyl cations on benzene.

c. Cyclobutyl Cations. Both the cyclopropyl carbanyl and cyclobutyl cations have a long, well-known history of controversy from both the experimental and the theoretical sides,⁵⁸ centered primarily on questions about their classical or nonclassical structure as well as on their relative energies. Nowadays, a general consensus is taking shape about the cause of this controversy as due primarily to the inherently flat potential energy surface of $C_4H_7^+$ and its sensitivity to perturbing environmental factors. In fact, only after the introduction of extended basis set *ab initio* calculations with electronic correlation, a satisfactory agreement was achieved between the theoretical description of the $C_4H_7^+$ potential energy surface⁵⁹ and the experimental evidence from NMR spectroscopy in low-nucleophilicity solvent systems.⁵⁸

After the introduction of both these procedures, the converging conclusion was reached for a $C_4H_7^+$ ion pattern dominated by the easy interconversion (activation energy: 0.6 kcal mol⁻¹) between the bisected, partially delocalized cyclopropylcarbanyl ion and the slightly more stable ($\Delta E = 0.05$ –0.7 kcal mol⁻¹) bicyclobutonium ion, prior to their slow isomerization to the 1-methylallyl structure, more stable by 9 kcal mol⁻¹.

A decisive contribution to this picture was provided several years before its consolidation by a decay study of cyclobutyl cation, using multitritiated cyclobutane, $c-C_4H_xT_{8-x}$ ($x = 0$ –6), as a precursor, carried out at a stage when SCF calculations were excluding cyclobutyl ion as a stable structure on the $C_4H_7^+$ potential energy surface.⁶⁰

Preliminary ICR studies demonstrated that $C_4H_7^+$ ions, of unknown structure(s), are by far the most abundant (85%) nucleogenic carbocation formed from the nuclear decay of monotritiated cyclobutane and survive undissociated for at least 10⁻⁶ s.²¹

Generation of $C_4H_xT_{7-x}^+$ ions from the decay of $c-C_4H_xT_{8-x}$ ($x = 0$ –6) in a large excess of suitable gaseous

Scheme 1

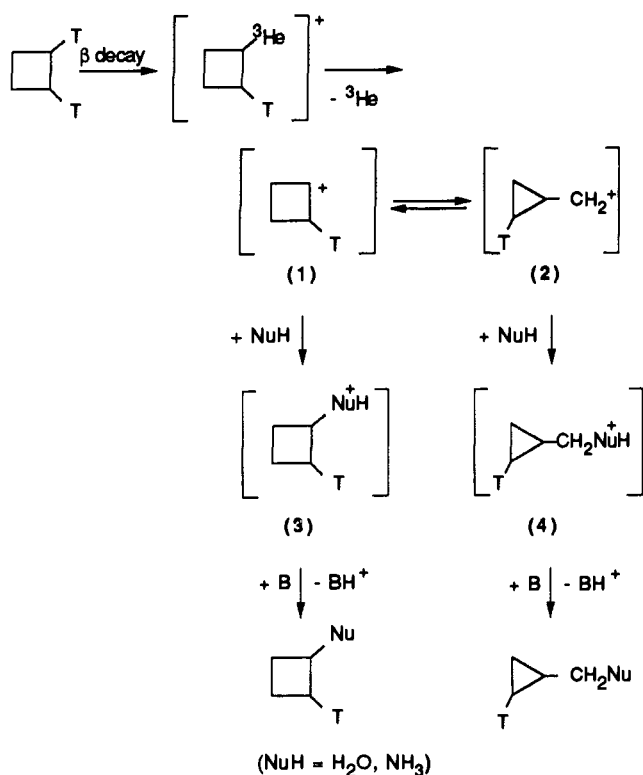

nucleophiles, such as H₂O (6-25 Torr) or NH₃ (400 Torr), yielded a complex mixture of labeled products.⁴² Nevertheless, formation of significant amounts of cyclobutyl (4-35%) and cyclopropylcarbinyl derivatives (3-36%) in all systems investigated provides compelling evidence for the existence of the cyclic ionic precursors, namely, a cyclobutyl (or a bicyclobutonium) and a cyclopropylcarbinyl cation. The reactions of the gaseous nucleogenic ions 1 and 2 with the nucleophile NuH (NuH = H₂O or NH₃), followed by proton transfer from the cyclic onium intermediates 3 and 4 to a gaseous base B, contained in the system, accounts for the formation of the observed tritiated products (Scheme 1).

The isolation of almost equimolar amounts of both cyclobutyl-Nu and cyclopropylcarbinyl-Nu under all conditions led to the conclusion that both ions 1 and 2 do indeed exist in the dilute gas state at least for the time (>10⁻⁹s) necessary to be trapped by the nucleophile and, therefore, must be regarded as fully legitimate ionic intermediates of comparable stability, characterized by significant local minima on the C₄H₇⁺ potential energy surface.

It should be noted that these conclusions stimulated a theoretical reexamination of the cyclobutyl ion problem,⁶¹ which opened the way to the present widely accepted view.

d. Cyclopentyl Cations. An investigation on the occurrence and the reactivity of cyclopentyl ions in the gas phase has been carried out by using the decay technique.⁴³ 1,2-T₂-Cyclopentane was allowed to decay in cyclopentane, at pressures ranging from 10 to 760 Torr, and the radioactive decay products were analyzed by radio-GLC. The combined absolute yields of the labeled products do not exceed 6-10% in all systems investigated, thus suggesting the formation of mono-tritiated cyclopentane, as the major labeled product,

via hydride ion transfer from unlabeled cyclopentane to the primary nucleogenic ion 5 (eq 9).

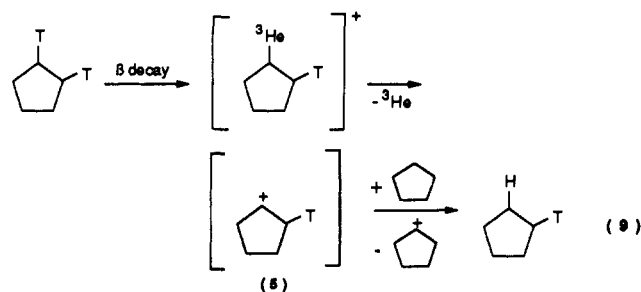

The results point to ion 5 as mostly retaining the cyclic cyclopentyl structure, with no tendency to undergo ring contraction or ring opening. Therefore, it is concluded that the nucleogenic cyclopentyl ions are formed in their ground state, or with an excitation energy insufficient to cause further dissociation or isomerization. The small fraction of the decay ions which receives an appreciable excitation from the β transition and which escapes collisional stabilization undergoes extensively fragmentation to C₁-C₄ hydrocarbons or isomerization to 1-pentene. The obtained picture well conforms to direct NMR results in favor of the existence of a stable, rapidly equilibrating cyclopentyl cation in FSO₃H-SbF₅ solution,⁶² and verifies independent ICR²¹ and theoretical evidence.

e. Cyclohexyl Cation. The cyclohexyl cation 6 is recognized as a stable, solvated intermediate in a variety of reactions occurring in solutions.^{1b} Attempts to detect 6 in the gas phase by structurally diagnostic mass spectrometric techniques or in superacids solutions by NMR spectroscopy invariably met with failure, the only observable species being the more stable 1-methylcyclopentyl isomer 7. These results led to the general consensus that cyclohexyl cation 6 does not exist in the free state but rearranges to 7 without activation.⁶³

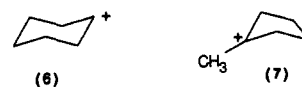

Application of the decay technique has shown that free cyclohexyl cation 6 does exist and has provided reliable estimates of its lifetime and of the barrier to its rearrangement into 7. Multitritiated cyclohexane, with an average T content of 2.2 ± 0.2 atoms per molecule, was allowed to decay at room temperature for periods of 9-12 months in liquid and gaseous systems containing a suitable nucleophile, such as CH₃OH, (CH₃)₄Si, or 1,4-C₄H₈Br₂.⁴⁴ Derivatives of unrearranged cyclohexyl cation are the only tritiated products detected by radio-GLC analysis of the liquid systems. For instance, only tritiated cyclohexyl methyl ether (49%) and cyclohexene (51%) are formed in liquid CH₃OH.

The product pattern from gaseous systems is dominated instead by derivatives of the rearranged ion 7 and shows a characteristic dependence on the pressure, but not on the nature, of both the bulk gas and the trapping nucleophile. For example, the fraction of the products retaining the cyclohexyl structure formed in (CH₃)₄C in the presence of CH₃OH decreases from 32% at 720 Torr to 10% at 200 Torr, becoming nearly undetectable below 50 Torr.

Scheme 2

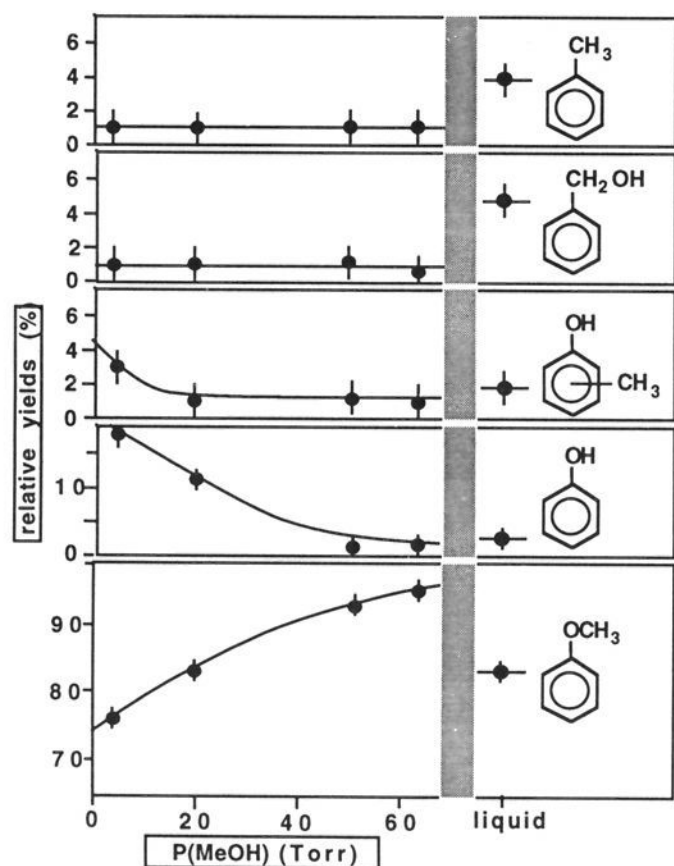
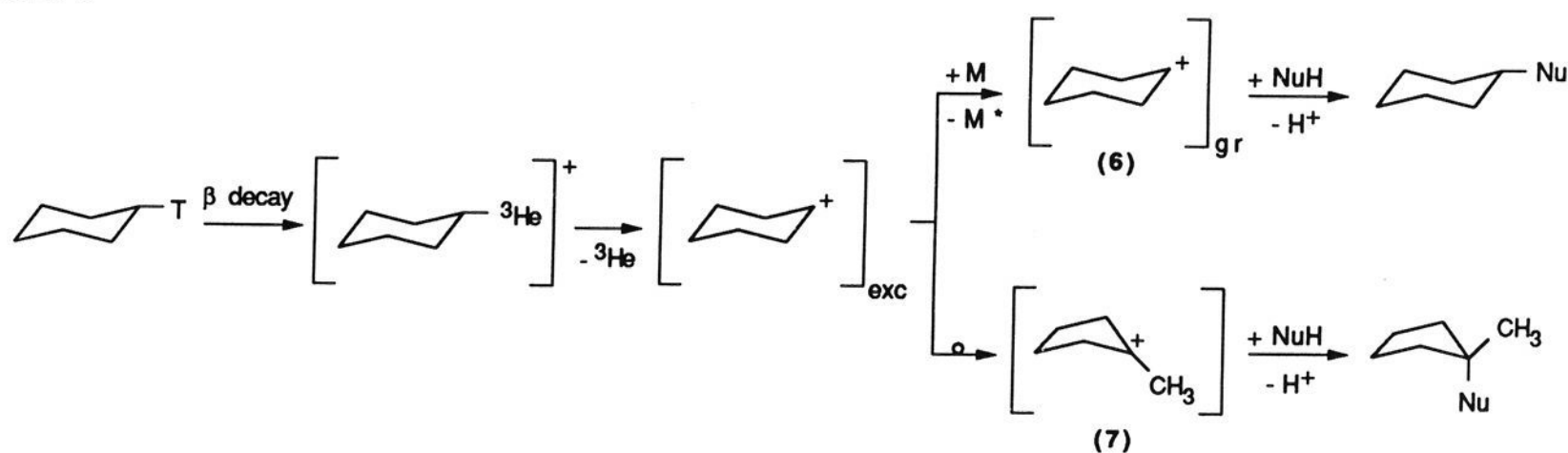

Figure 3. Relative distribution of the tritiated aromatic products from the attack of phenylium ion on methanol.

The nucleogenic cyclohexyl ions, formed in a distorted structure and, hence, with excess internal energy, can either undergo collisional stabilization or isomerization to 7 (Scheme 2).

In the liquid phase, isomerization is prevented by fast collisional deactivation and by the short lifetime of free 6 before trapping. In the gas phase, the competition between deactivation and isomerization is controlled by the pressure of the bulk gas (M in Scheme 2) and by the concentration of the nucleophile NuH, which affects the lifetime of the free ion. The results of the pressure-dependence studies lead to a lifetime of free 6 in excess of 10^{-8} – 10^{-7} s. Furthermore, a Rice–Ramsperger–Kassel–Marcus (RRKM) treatment, based on the assumption that the “deformation energy” of the nucleogenic cyclohexyl cation is *ca.* 30 kcal mol⁻¹, leads to a calculated energy barrier of 5–9 kcal mol⁻¹ for the 6 → 7 rearrangement, depending on the number of effective oscillators chosen. Such estimates have later been verified by a temperature-dependence study carried out in dense gases with a different technique, in which an activation energy of 7.4 ± 1 kcal mol⁻¹ has been measured.⁶⁴

The relatively low activation barrier to the isomerization process explains the failure to detect gaseous 6 with structurally diagnostic mass spectrometric tech-

nique, because complete rearrangement to 7 can be expected to occur well before structural assay under typical mass spectrometric conditions.

f. Phenylium Ion. The occurrence of phenylium ion as a charged intermediate from the decomposition of benzenediazonium salts in condensed media, its electronic configuration (singlet 8 *vs* triplet 9), and its reactivity have been the focus of lively debate during the past 50 years.⁶⁵ The inherent interest on this matter has been recently further enhanced by a chasing interplay between experimental and theoretical approaches stimulated by the decay work.



1,4-T₂-Benzene⁴⁶ was allowed to decay at 25 °C in liquid CH₃OH or in gaseous CH₃OH at pressures ranging from 5 to 65 Torr.⁶⁶ The relative distribution of the tritiated products recovered from the decay experiments is reported in Figure 3. Under all conditions, ring-tritiated anisole is the major product, arising from the reaction sequence shown:

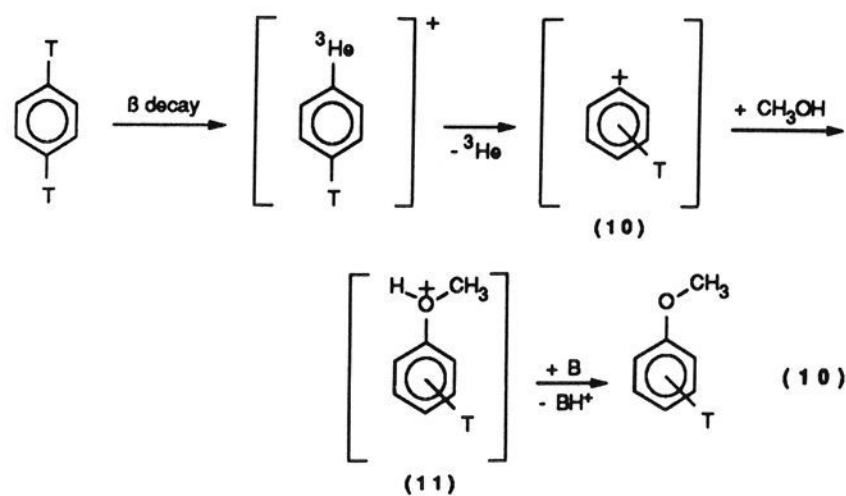

The nature of the major product indicates that, despite its excess internal energy arising from the “deformation energy” from its formation process, the nucleogenic ion 10 maintains the singlet state configuration, as in 8.

The tritium distribution within labeled anisole from eq 10 was determined by chemical degradation procedures, based on the gradual replacement of the ring hydrogens by suitable inactive groups. Whereas the product from liquid systems retains 100% of the label in the original *para* position, the T distribution in the product from the gaseous systems depends on the CH₃OH concentration, which determines the lifetime of

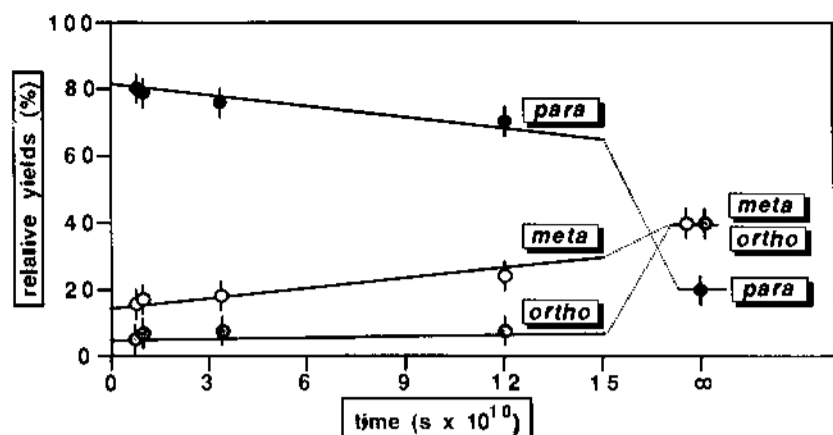
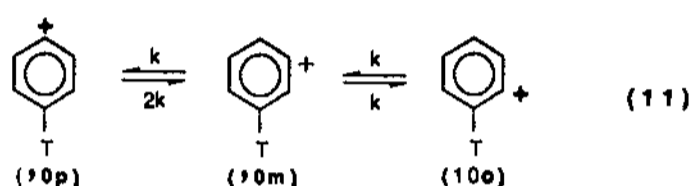

Figure 4. Dependence of the isomeric composition of ring-tritiated anisole on the interval between collisions in methanol.

the free phenylum ion, as shown in Figure 4. The apparent T migration in **10** and its pressure dependence point to a degenerate rearrangement of the nucleogenic phenylum ion via 1,2-hydride ion shifts (eq 11):



The complete retention of the original T distribution observed in the anisole from liquid systems indicates that automerization in eq 11 is slow in comparison with the collisional frequency in the condensed phase. A value of $k = 10^7\text{--}10^8 \text{ s}^{-1}$ was estimated from the best fit of the experimental isomeric distribution of tritiated anisole from the gaseous systems as a function of the lifetime of the free phenylum ion and the integrated rate equations calculated for the automerization sequence (eq 11), within the assumption that the last two steps of eq 10 are fast.

Automerization of free phenylum ion suggested by decay experiments has stirred a lively debate. In fact, the results of early theoretical studies led to high values, from 44 to 77 kcal mol⁻¹, of the E^* activation barrier to 1,2-H shifts within C₆H₅⁺.⁶⁷ Even taking into account the excess internal energy E^0 associate with the "deformed" geometry of the decay ions **10**, the theoretically calculated energy difference $\Delta E = E^* - E^0$ was sufficiently large (21–52 kcal mol⁻¹) to call into question the automerization process. Hence, it was suggested that T scrambling might be a secondary process, involving charged species other than free phenylum ion, e.g. **11**.⁶⁸

Much experimental and theoretical work has since been devoted to the question. Further decay experiments, carried out by using methyl halides as phenylum ion interceptors to eliminate any conceivable T scrambling in the ensuing onium intermediates (analogous to **11**), conclusively showed that T migration does occur within free phenylum ion **10**, before its trapping by the nucleophilic reagent.⁶⁹ Refinement of the computational techniques, in particular use of extended-basis *ab initio* methods, has actually succeeded in reconciling theory with the experiment. Gradually, the theoretically calculated ΔE gap has narrowed down to the present value of ca. 8 kcal mol⁻¹, deduced from the latest estimate of E^* , 40 kcal mol⁻¹, and an E^0 value of 32 kcal mol⁻¹, computed at the MP2/6-31G* level of theory.⁷⁰ In conclusion, the debate raised by the automerization of phenylum ion represents an excellent example of

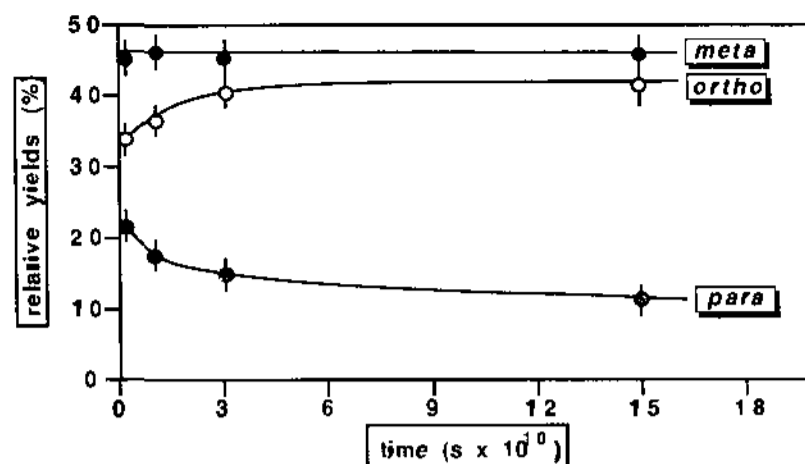
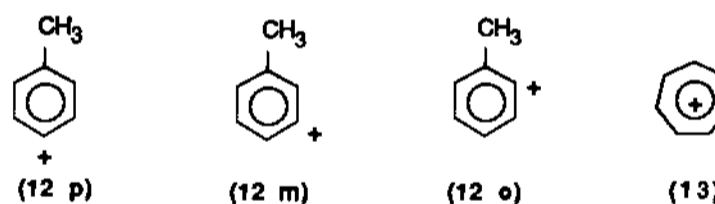

Figure 5. Dependence of the isomeric composition of methyl tolyl ethers on the interval between collisions in methanol.

the impact of the decay technique on theoretical ion chemistry and of the incentive it has provided to its refinement. Along this line, it cannot be excluded that further refinement of the theoretical approach, e.g. at the post-SCF level, may provide a complete correspondence between the experimental and the theoretical E^* (close to 32 kcal mol⁻¹) for the automerization of phenylum ion.

g. Tolylium Ions. The question of the phenylum ion automerization has been extended to its homologues, the tolylium ions **12**, with the intention of understanding the intimate isomerization mechanism governing complete hydrogen and carbon scrambling in the C₇H₇⁺ fragments from electron impact of suitable precursors.⁷¹ Complete scrambling in C₇H₇⁺ ions implies, in fact, the intermediacy of a common structure, hypothesized as the tropylium ion **13**, whose mechanism of formation from isomeric C₇H₇⁺ ions is not completely clear.



Application of the decay technique has contributed to the understanding of the low-energy isomerization mechanisms in nucleogenic C₇H₇⁺ ions, while excluding among these that leading to a tropylium ion structure.

Ring-multitritiated toluene, with a T atom content of 33% at the *ortho*, 45% at the *meta*, and 22% at the *para* position,⁴⁵ was allowed to decay in liquid CH₃OH, or in a gaseous CH₃OH at pressures ranging from 6 to 100 torr.⁷² The only aromatic products from the reaction of the nucleogenic tolylium ions **12** with CH₃OH are the isomeric methylanisoles, arising from reaction sequences analogous to eq 10.

The nature of the tritiated products indicates, in harmony with the conclusions reached for phenylum ion, that the isomeric tolylium ions **12** are generated from the decay of their multitritiated toluene precursor in the singlet configuration and maintain this electronic state despite their excess internal energy from the structural "deformation" associated with the nuclear transition.

While the distribution of T in the labeled methylanisole from liquid systems closely reflects that of the T atoms in the ring of the toluene precursor, the product distribution from gaseous systems depends on the CH₃OH concentration which defines the lifetime of the free tolylium ions, as shown in Figure 5. The results show

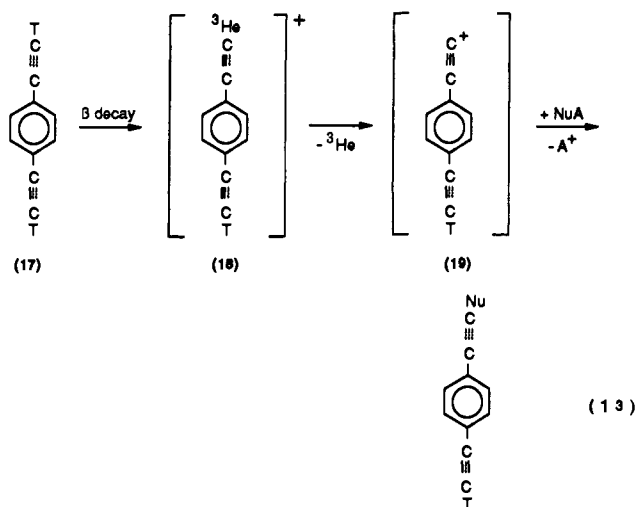

However, as mentioned in part B of section II, this energy can be readily provided by the recoil energy imparted to the ${}^3\text{He}$ atom by the energetic β -particle from the decay event, so that a significant fraction of the primary species 18 is expected to dissociate into 19 and ${}^3\text{He}$ before interacting with the nucleophile NuA. On these grounds, it is concluded that, while both 18 and 19 may contribute to the formation of the neutral products, nevertheless the decay results unequivocally demonstrated that alkynyl cations, such as 19 can be readily generated and investigated not only in the gas phase, but also in solution.

2. Reactivity of Carbocations toward Organic Compounds

a. Saturated Carbenium Ions. i. Alkyl Cations with Alkanes. A significant fraction of the study of the reactivity of nucleogenic alkyl cations refers to their interaction with simple alkanes, including the unlabeled counterparts of their tritiated precursors. For example, studies have been made on the gas-phase reactions of CT_3^+ with methane and methane/propane mixtures, of $\text{C}_2\text{H}_4\text{T}^+$ with ethane and propane, of $\text{C}_3\text{H}_6\text{T}^+$ with propane, and of $\text{c-C}_5\text{H}_8\text{T}^+$ with cyclopentane.

Nuclear decay of CT_4^{38} in CH_4 (760 Torr, room temperature) and 32:1 or 1:6 $\text{CH}_4/\text{C}_3\text{H}_8$ mixtures (760 Torr, room temperature) leads to the formation of several major products, *i.e.* CHT_3 (5%), HT (29%), and $\text{C}_2\text{H}_x\text{T}_{4-x}$ ($x = 2, 3$) (11%) in pure CH_4 ; CHT_3 (5%); HT (34%); and $\text{C}_2\text{H}_x\text{T}_{6-x}$ ($x = 3-5$) (49%) in $\text{CH}_4/\text{C}_3\text{H}_8 = 32:1$; CHT_3 (74%), HT (17%), and $\text{C}_2\text{H}_x\text{T}_{6-x}$ ($x = 3-5$) (7%) in $\text{CH}_4/\text{C}_3\text{H}_8 = 1:6$.^{38a}

These results are consistent with a nucleogenic CT_3^+ ion undergoing the competing reactions 14 and 15 (H denotes either a hydrogen or a tritium atom).

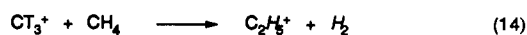

The C_2H_5^+ from eq 14 is unreactive toward CH_4 , but undergoes a fast hydride ion transfer from C_3H_8 (eq 16):

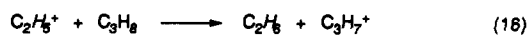

Kinetic analysis of the reactions involved in these systems indicate that (i) the reaction rates of CT_3^+ with

CH_4 and C_3H_8 are comparable; (ii) the reaction of CT_3^+ with CH_4 leads to the formation of the ethyl cations, without detectable hydride ion transfer from CH_4 to CT_3^+ ; (iii) the reaction of CT_3^+ with C_3H_8 involves exclusively a hydride ion abstraction, with no further intermolecular hydrogen-atoms mixing. The ethyl ions do not react appreciably with CH_4 , but readily abstract a hydride ion from C_3H_8 .

These conclusions support, and extend to much higher pressure, the mass spectrometric⁸⁵ and radiolytic results⁸⁶ on ion-molecule reactions in CH_4 .

In tetraalkyl silanes R_4Si ($\text{R} = \text{CH}_3, \text{C}_2\text{H}_5, \text{C}_3\text{H}_7, \text{C}_4\text{H}_9$), instead, nucleogenic CT_3^+ behaves as an acceptor of both a H^- or a R^- ion. In general, the tendency toward R-SiR_3 bond cleavage into CT_3R and SiR_3^+ decreases with increasing chain length. Exchange reactions of the CH_3 groups of R_4Si by CT_3^+ is also observed.⁸⁷

In another set of experiments,³⁹ 1,2- $\text{C}_2\text{H}_4\text{T}_2$ was allowed to decay in pure C_2H_6 , in $\text{C}_2\text{H}_6 + 0.5\% \text{O}_2$, and in $\text{C}_3\text{H}_8 + 0.5\% \text{O}_2$, at room temperature and atmospheric pressure. The most outstanding result of these experiments is the low absolute yields (<25%) of the tritiated products. This is explained by the quasi-resonant hydride ion transfer (eq 17), yielding a $\text{C}_2\text{H}_5\text{T}$ product which cannot be discriminated from the starting 1,2- $\text{C}_2\text{H}_4\text{T}_2$ compound. Indirect support for

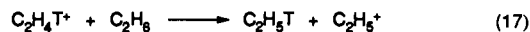

this hypothesis comes from the observation that the total yield of the identified products is not affected by the presence of propane. If the $\text{C}_2\text{H}_4\text{T}^+$ ions contribute significantly to the formation of the labeled products in pure ethane, their yields should substantially decrease in propane, owing to the hydride ion transfer (eq 16), which is known to occur with high efficiency.⁸⁸ The fact that the total yield of labeled products other than $\text{C}_2\text{H}_5\text{T}$ remains unaffected by addition of C_3H_8 points to their origin from the fragmentation processes that take place in *ca.* 20% of the decay events and from the reactions of the ensuing fragments (see part B of section II).

The reaction of the labeled carbocations from β decay of 1,2- $\text{C}_3\text{H}_6\text{T}_2$ with C_3H_8 were investigated both in the gas phase at 760 Torr at room temperature, and in the liquid phase at -130°C .⁴⁰ In analogy with the conclusions reached in the previous systems, the limited absolute yields of the labeled products (*ca.* 35%) from the gas-phase runs are consistent with the efficient hydride ion transfer from C_3H_8 to the nucleogenic $\text{C}_3\text{H}_6\text{T}^+$, yielding $\text{C}_3\text{H}_7\text{T}$ which cannot be discriminated from its $\text{C}_3\text{H}_6\text{T}_2$ precursor. The labeled products, other than $\text{C}_3\text{H}_7\text{T}$, are formed exclusively from the fragmentation of the *ca.* 20% fraction of highly excited $\text{C}_3\text{H}_6\text{T}^+$ ions and from their reactions with C_3H_8 . In liquid C_3H_8 , the only major product is propane, along with a smaller amount of HT. This finding suggests that, when the decay takes place in liquid propane, most of the nucleogenic $\text{C}_3\text{H}_6\text{T}^+$ ions are stabilized. Even in those cases when the nuclear transition leaves the organic ion in a highly excited state, its dissociation is limited to the first step, *i.e.* eq 18:

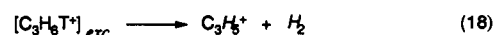

Scheme 3

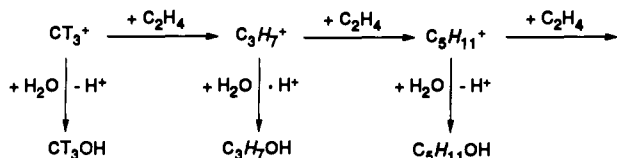

The C_3H_5^+ ion, reacting with C_3H_8 , eventually gives rise to tritiated propene by the hydride ion transfer (eq 19):

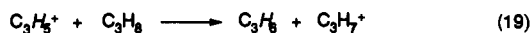

ii. Methyl Cations with Unsaturated Hydrocarbons.

The decay technique has been conveniently applied for investigating the reactivity of CT_3^+ ions toward alkenes and arenes. Thus, nucleogenic CT_3^+ ions were generated in $\text{C}_2\text{H}_4/\text{H}_2\text{O}$ gaseous mixtures (molar fraction of $\text{C}_2\text{H}_4 = 0.5\text{--}0.8$) at room temperature with the intention of evaluating the relative reactivity of the ion toward typical π - and n -type compounds in the gas phase and of trapping the ionic intermediates of the cationic ethylene polymerization initiated by CT_3^+ (Scheme 3).⁸⁹

Experimental results confirm the expectation that increasing the C_2H_4 molar fraction favors the occurrence of the polymerization channel and, thus, the formation of C_3 and C_5 alcohols. It is noteworthy that secondary and tertiary C_3 and C_5 alcohols were exclusively recovered from the decay samples, whereas the primary alcohols were completely absent. This finding leads to the conclusion that the primary carbocations initially formed in the polymerization pathway are sufficiently long lived to undergo extensive isomerization to thermodynamically more stable structures, in full agreement with the conclusions reached in part A.1.b.^{54,55,57} In all systems, the yield of labeled methanol exceeds the value expected from an unselective attack of CT_3^+ on all the nucleophiles present, *i.e.* H_2O and C_2H_4 . For example, a 50% yield of a methanol would be expected from the equimolar $\text{C}_2\text{H}_4/\text{H}_2\text{O}$ gaseous mixture. The actual experimental value (82.5%) largely exceeds this statistical value. The data make it possible to estimate an approximate rate constant ratio of *ca.* 0.3 for the two competing first steps of Scheme 3.

The study of the reactivity of CT_3^+ toward unsaturated hydrocarbons has been extended to arenes and heteroarenes as well. A first set of investigations involves as substrates a variety of alkylbenzenes, *i.e.* benzene, toluene, isomeric xylenes, and isopropyl- and *tert*-butylbenzene, in both the gaseous and the condensed phase. In all systems investigated, a constant finding is the observation of the labeled methylated derivatives of the aromatic substrate, always accompanied by variable amounts of the tritiated substrate itself. Thus, almost equimolar amounts of labeled toluene and of isomeric xylenes are recovered from the attack of CT_3^+ on toluene in the gas phase, while, in the liquid toluene, the total yield of xylenes exceeds that of toluene by a factor of *ca.* 4.^{6,90}

The apparent intramolecular selectivity of the methyl ion, deduced from the isomeric composition of the xylenes formed in the pressure range 36–350 Torr, *i.e.* 19.5% *ortho*, 68.5% *meta*, 12.0% *para*, is characterized by predominant *meta* orientation which, *prima facie*,

contrasts with the obvious electrophilic character of the attack. However, one has to take into account the extremely high exothermicity of the methylation process (eq 20) estimated around 90 kcal mol⁻¹, which gives rise

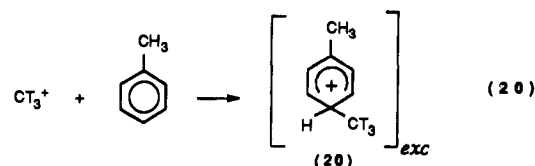

to highly excited primary arenium intermediates **20**, wherein extensive intramolecular isomerization into the most stable structure, *i.e.* the 2,4-dimethylbenzenium ion **21**, may readily take place (eq 21).

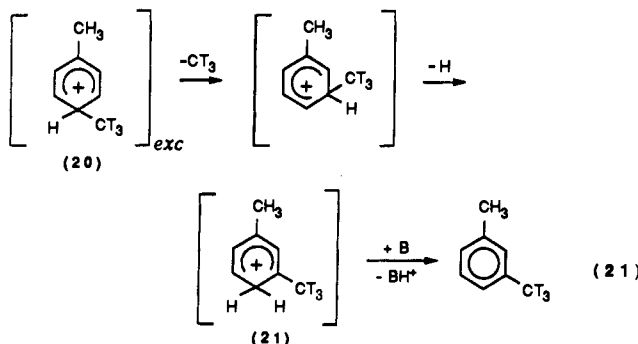

Clearly, even at 350 Torr, collision deactivation cannot prevent extensive isomerization of the excited, primary methylated arenium ions, *e.g.* **20**, and, therefore, the observed composition of xylenes does not reflect the initial selectivity of the attack, being largely thermodynamically controlled.

This view is supported by the results of the liquid-phase methylation of toluene with free CT_3^+ ions generated *in situ* by the decay of dissolved CT_4 . The much higher efficiency of collisional stabilization in the liquid phase reduces, if not entirely suppresses, secondary isomerization (eq 21), and the isomeric composition of xylenes, 40% *ortho*, 27% *meta*, and 33% *para*, reflects more faithfully the relative abundances of the primary arenium intermediates, showing the electrophilic character of the reagents. This is further confirmed by its limited, but significant, substrate discrimination ($k_T/k_B = \text{ca. } 2$) shown in the liquid-phase competition experiments, a selectivity which is completely lost in the gaseous systems ($k_T/k_B = 0.8\text{--}0.9$) as a result of extensive isotopic scrambling, group migration, and fragmentation of the excited primary intermediates.

Further evidence for extensive rearrangements in excited primary methylated intermediates in the gas phase is provided by the results from the methylation of isomeric xylenes.^{30a} Regardless of the specific isomer used as the starting substrate, gas-phase attack of CT_3^+ yields eventually all three possible trimethylbenzenes.

The profound alterations of the mechanistic picture revealed by comparison of liquid- and gas-phase results and by the pressure effect are a serious caveat against straightforward generalization of gas-phase data as a measure of the reactivity and selectivity of the ionic reactant,^{30b} as for instance, those from mass spectroscopic studies of ion-molecule reactions, obtained under

Scheme 4

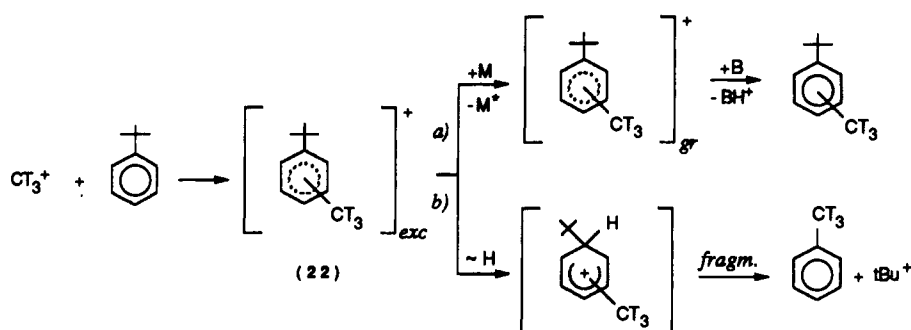

conditions that cannot ensure effective quenching of the excited primary intermediates.

The results of a comparative study of the gas- and liquid-phase methylation of *tert*-butylbenzene with nucleogenic CT_3^+ ions fully support the above conclusions.⁹¹ The excited arenium ions **22** from the exothermic methylation reaction are effectively stabilized in the liquid phase (path a of Scheme 4), and, following deprotonation, give *tert*-butyltoluenes as the major products (59% yield). Despite the recognized migratory ability of the *tert*-butyl group in the excited arenium ion, the isomeric composition of the *tert*-butyltoluenes still reflects the selectivity of the attack, with a *para*/*ortho* 0.5 *meta* ratio of 2:1. Incidentally, the extent of substitution *ortho* to the bulky *tert*-butyl group (25%), when compared to the corresponding value in the methylation of toluene (40%), provides an estimate of the steric requirements of the free, unsolvated methyl cation. Methylation of gaseous *tert*-butylbenzene (100 Torr) leads to an entirely different product pattern, giving high yields of labeled species arising from extensive isotopic scrambling, isomerization, and fragmentation, including toluene (14%), *tert*-butylbenzene (74%), *tert*-amylbenzene (7%), at the expenses of *tert*-butyltoluenes (3.4%) (e.g. path b of Scheme 4).

Comparison of these results with those from the methylation of toluene under similar conditions shows that more effective fragmentation channels, i.e. path b of Scheme 4, are available to the excited arenium ions from *tert*-butylbenzene, i.e. **22**. In particular, the loss of the very stable *tert*-butyl ion, albeit endothermic by some 18 kcal mol⁻¹, is largely allowed by the excess internal energy (ca. 85 kcal mol⁻¹) of the arenium ion, and is strongly supported by the high yield of toluene. This finding closely recalls the parallel behavior observed in the chemical ionization mass spectrometry of aromatic hydrocarbons containing the *tert*-butyl substituent.⁹²

The above application of the decay technique in the field of electrophilic aromatic substitutions proved of value in estimating the intrinsic reactivity and selectivity of CT_3^+ ions and comparing the results with those from the study of the corresponding reactions in solution. The same approach has been also used to investigate the intrinsic reactivity of heteroaromatic substrates toward several ionic electrophiles, including CT_3^+ .

In fact, it is well known that, in solution, electrophilic substitution in pyrrole and furan occurs predominantly at the α carbons, although most theoretical calcula-

tions⁹⁴ at the semiempirical and *ab initio* levels assign a larger electron density to the β than to the α positions. Moreover, the corresponding molecular electrostatic potentials established within the encounter pair from an isolated heteroaromatic molecule and a positive point charge indicate favorable pathways of electrophilic attack at the β ring carbons, as well as at the heteroatom.

Such discrepancies between theory and experimental data can, in principle, be traced either to failure of the theoretical methods or to profound effects of the reaction environment, which may mask the intrinsic directive properties of the heteroaromatic compounds.⁹⁵

To discriminate between these possibilities, a variety of nucleogenic and radiolytic carbocations were allowed to react in the gas phase with simple five-membered heteroarenes, such as pyrrole, *N*-methylpyrrole, furan, and thiophene. The nucleogenic carbocations investigated were CT_3^+ from CT_4 , *p*-T-phenylium ion from 1,4- T_2 -benzene, *p*-T-benzoyl cation from 1,4- T_2 -benzene/CO mixtures, and $^3\text{HeT}^+$ from T_2 . Here, the results concerning the reaction with CT_3^+ are presented. Those relative to the other electrophiles will be presented below.

The CT_3^+ ion, conveniently generated by the β decay of CT_4 , was allowed to react in the gas phase with pyrrole, *N*-methylpyrrole, furan, and thiophene (total pressure 150 Torr, $T = 100^\circ\text{C}$).^{33,96} In all systems investigated, two major categories of labeled products were recovered: the methylated and the tritiated substrates. Their overall absolute yield ranges from around 98% for pyrrole and *N*-methylpyrrole to 60% for thiophene, whereas it barely amounts to 38% for furan. This different behavior is due to the presence in furan and thiophene of *n*-centers (the O and the S atom, respectively) which efficiently compete with the π systems for the electrophile (see part v of this section).

Although possibly affected by partial isomerization and fragmentation of the ensuing primary intermediates, a distinct preference of the free, unsolvated CT_3^+ ion for the α positions of pyrroles [72% (pyrrole); 61% (*N*-methylpyrrole)] is observed, which contrasts with the opposite directive properties of the same substrates toward gaseous radiolytic carbocations, such as *t*- C_4H_9^+ and *i*- C_3H_7^+ ,⁹⁷ ranked among the hardest carbocations. Furan and thiophene undergo preferential α substitution [68% (furan); 55% (thiophene)] from the soft electrophile CT_3^+ . The same orientation properties have been observed as well toward hard carbocations, e.g. *t*- C_4H_9^+ and *i*- C_3H_7^+ .

The behavior of CT_3^+ toward the heteroarenes studied is explained in terms of the energy gap between the HOMO of the heteroarene and the LUMO of the

alkylating reagent. Within the framework of the charge and frontier orbital control concept,⁹⁸ the energy gap between the HOMO of the heteroarene and the LUMO of a "hard" ionic electrophile, such as $t\text{-C}_4\text{H}_9^+$ and $i\text{-C}_3\text{H}_7^+$, is relatively large. The total perturbation energy in the orbital interaction is primarily determined by electrostatic interactions (a "charge-controlled" reaction), favoring attack of the ionic electrophile on the ring sites of the heteroarene with the highest net negative charge (the β position of pyrroles, the heteroatom of furan, and the α positions of thiophene). As the energy level of the LUMO of the electrophile is lowered, as in the case of the "soft" CT_3^+ cation, the total perturbation energy in the orbital interactions is determined by extensive mixing between the HOMO of the donor (the heteroarene) and the LUMO of the acceptor (the electrophile) (a "frontier-controlled" reaction). In this case, the exchange mainly involves the frontier π electrons of the heteroarene, which are predominantly located at their α carbons.

iii. Benzyl Cations with Aromatic Hydrocarbons.

As shown in the previous section, the decay technique is well suited for the comparative kinetic and mechanistic studies in different media. The reactivity of the same charged species can be evaluated in different environments, especially in cases where conventional approaches are deeply affected by the presence of the solvent and the counterion which modify the real nature of the ionic species, and therefore its reactivity.

The study presented in this section refers to another interesting case, *i.e.* the Friedel-Crafts benzylation reaction. Benzylation has been the subject of detailed kinetic analysis, aimed at rationalizing its peculiar selectivity in the framework of general models of aromatic reactivity. Aromatic benzylation does not follow the Brown relationship between reactivity and orientation, in fact its low substrate discrimination, reflected by a low ratio of the rate constant for toluene to the rate constant for benzene, contrasts with its high positional selectivity. To explain this and other results, Olah has suggested a variable transition-state model, in which the high reactivity of strong electrophiles, such as the benzyl ion, is determined by an early transition state leading to an oriented π complex which subsequently evolves into isomeric σ complexes.⁹⁹ Other workers, noting that formation of the benzylation species by Friedel-Crafts catalysts is frequently rate determining, suggested that alkylation occurs at, or near to, the diffusion limit, which provides an alternative explanation for the low substrate selectivity that does not conflict with the observed positional discrimination.¹⁰⁰

The problem is particularly amenable to the decay technique, because in liquid-phase decay experiments one does not have to worry, as in conventional studies, that the selectivity changes observed in different media are affected by simultaneous modifications of the electrophile, whose nature may change from a solvated ion to a tight ion pair to a polarized complex, and so on. Instead, the influence of the medium can be traced essentially to its specific interaction with the benzyl cation, initially free and lacking a counterion.

Application of the decay technique has involved dissolution of $\text{C}_6\text{H}_5\text{CH}_x\text{T}_{3-x}$ ($x = 0, 1$)⁴⁵ into different solvents, such as neat aromatics, *n*-hexane, carbon

tetrachloride, and nitromethane, all containing benzene, toluene, methanol, and their mixtures.¹⁰¹ The labeled products from the decay are diphenylmethane, isomeric benzyltoluenes, and benzyl methyl ether, whose yields, measured in competition experiments, allow evaluation of the relative reactivity of the nucleophiles toward free benzyl ions and whose isomeric composition allows determination of the positional selectivity.

The first clear-cut answer provided by the decay experiments is that reaction of benzyl ions with benzene and toluene is not diffusion controlled. (For instance, benzylation of C_6H_6 occurs at a specific rate of *ca.* $5 \times 10^7 \text{ mol}^{-1} \text{ L s}^{-1}$, well below the limiting value, $2 \times 10^{10} \text{ mol}^{-1} \text{ L s}^{-1}$, typical of diffusion controlled processes in the system of interest.)

The kinetic and mechanistic features emerging from the decay experiments, in particular, the substrate and positional selectivity of the benzyl cation in different solvents and their dependence on the experimental conditions, outline a general reactivity pattern based on eq 22 where the formation of the arene-electrophile adduct **24**, probably the π complex envisaged by Olah, is the rate-limiting step, while the orientation is controlled at a later stage, involving formation of isomeric σ complexes.

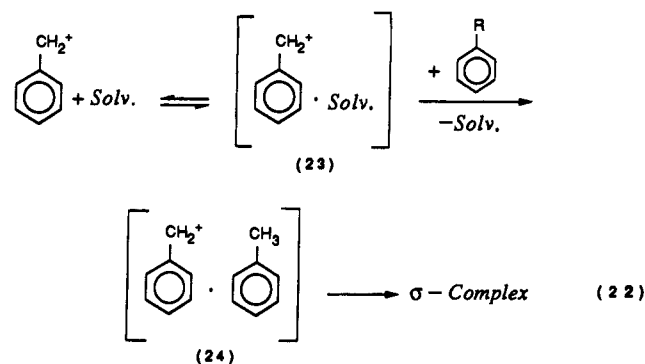

iv. Methyl Cations with *n*-Bases. The reactions of nucleogenic CT_3^+ ions with *n*-type nucleophiles have been the matter of a sustained research effort since the introduction of the decay technique.¹⁰² A variety of *n*-type substrates have been employed in these studies, including H_2O ,^{32,103} alcohols,^{103,104} ethers,^{87a,105} ketones,¹⁰⁶ carboxylic acids and esters,¹⁰⁷ hydrogen and alkyl halides,^{32,108} and amines.¹⁰⁹

All the oxygen-containing organic compounds investigated can be represented by the following general formulas: ROR' , with R and $\text{R}' = \text{H}$, alkyl, trialkylsilyl, trialkoxysilyl; RCOR' , with $\text{R}' = \text{H}$, alkyl and $\text{R} = \text{alkyl}$; RCOOR' , with $\text{R}' = \text{H}$, alkyl and $\text{R} = \text{alkyl}$.

In the reaction of CT_3^+ with the above classes of oxygenated substrates, it is possible to distinguish two main pathways (Scheme 5). One involves the attack of CT_3^+ on the alcoholic or etheral oxygen center, yielding the oxonium intermediates **25** (path a) and **26** (path b), the other proceeds via the attack of CT_3^+ on the carbonyl oxygen atom with the formation of alkoxy-carbenium intermediates **27** (path c) and **28** (path d).

Depending upon their internal energy, the intermediates **25**–**28** evolve into their final products either by a monomolecular mechanism (as shown in Scheme 5) or by intervention of another molecule of substrate.

Accordingly, the major product from the gas-phase attack of CT_3^+ on water^{32,103} and alcohols^{103,104} (ROR' ;

Scheme 5

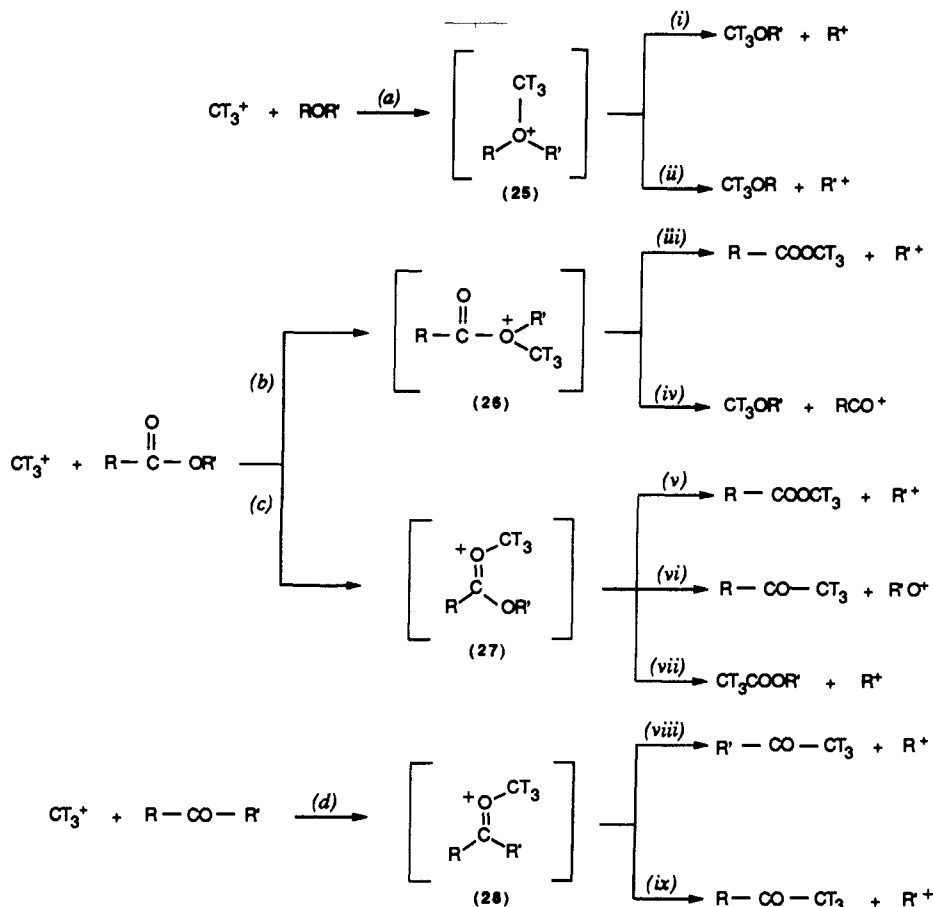

$R' = H$) is methanol, arising from the unimolecular dissociation i of the excited intermediate 25. Among unimolecular processes, in fact, pathway i is most profitable from the energetic standpoint and, thus, prevails over other conceivable unimolecular reactions, e.g. path ii, which would lead to the corresponding CT_3OR products. As a result, the yield of tritiated CT_3OH from a series of alcohols increases in the R order: 86% ($R = \text{methyl}$), 81% ($R = \text{ethyl}$), 85% ($R = n\text{-propyl}$), 94% ($R = n\text{-butyl}$), and 100% ($R = \text{isobutyl, } sec\text{-butyl, and isopropyl}$).^{104a} On the contrary, in solid phase where bimolecular processes are favored, the main reaction products are ethers CT_3OR .^{104b}

A minor fraction of very excited complexes 25 may undergo a different unimolecular fragmentation route, yielding labeled methylene, which is able to insert into the C-H bonds of the alcohol, giving rise eventually to alcohols containing one more carbon atom (Scheme 6).^{103,104}

In the reaction of CT_3^+ with gaseous ethers ROR' ,^{87a,105} the dissociation of the excited intermediate 25 (R and $R' = \text{alkyl or trialkylsilyl groups}$) gives both CT_3OR (path i of Scheme 5) and CT_3OR' (path ii of Scheme 5), their yield ratios depending upon the stability of the R^+ and R'^+ fragments. In the case of alkyl aryl ethers, the reaction pattern is further complicated by the presence of the π system, which represents an additional nucleophilic center. These reactions will be presented in part v of this section.

The attack of CT_3^+ ions on acids $RCOOH$ and esters $RCOOR'$ leads to the formation of $RCOCT_3$, CT_3OR' , $RCOCT_3$, and CT_3COOR' , in agreement with the

Scheme 6

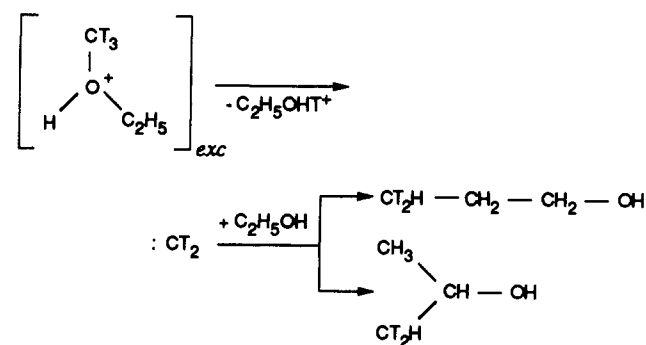

Table 3. Relative Yields of the Products from the Gas-Phase Reactions of Methyl Cations with Esters of the CH_3COOR Type

reaction	reaction products	yield (%)
$CT_3^+ + CH_3COOCH_3$	methyl acetate	89 ± 2
	dimethyl ether	11 ± 1
	acetone	Traces
$CT_3^+ + CH_3COOC_2H_5$	methyl acetate	83 ± 4
	ethyl acetate	7 ± 1
	methyl ethyl ether	9 ± 2
	acetone	1
$CT_3^+ + CH_3COOC_3H_7$	methyl acetate	87 ± 1
	propyl acetate	5 ± 1
	methyl propyl ether	4 ± 1
	acetone	4 ± 1

relevant reaction network of Scheme 5.¹⁰⁷ The results given in Table 3 were obtained for alkyl acetates ($R' = CH_3, C_2H_5, \text{ and } C_3H_7$).^{107c} From Table 3, it appears that labeled methyl acetate is the major product

Table 4. Relative Yields of Products from Gas-Phase Reactions of Methyl Cations with Esters RCOOC₂H₅

reactions	reaction products	yield (%)
CT ₃ ⁺ + HCOOC ₂ H ₅	methyl formate	55 ± 8
	acetaldehyde	3 ± 2
	ethyl acetate	7 ± 2
	methyl ethyl ether	2 ± 1
	methanol	32 ± 5
CT ₃ ⁺ + CH ₃ COOC ₂ H ₅	methyl acetate	83 ± 4
	acetone	1
	ethyl acetate	7 ± 1
	methyl ethyl ether	9 ± 2
	methanol	9 ± 2
CT ₃ ⁺ + C ₂ H ₅ COOC ₂ H ₅	methyl propionate	52 ± 1
	methyl ethyl ketone	6 ± 1
	ethyl acetate	33 ± 1
	methyl ethyl ether	10 ± 1

from all decay systems, whereas CT₃OR', CT₃COOR', and RCOCT₃ are formed in significantly smaller amounts. These results do not allow one to establish whether the preferred site of attachment of CT₃⁺ to esters is the ethereal or the carbonyl oxygen, albeit there is some independent mass spectrometric evidence in favor of the preferred formation of intermediate 26.¹¹⁰ When using ethyl esters of carboxylic acids, with R = H, CH₃, or C₂H₅, the results reported in Table 4 were obtained.^{107b}

They point to the formation of RCOCT₃, as the major labeled products, together with smaller quantities of CT₃OR', CT₃COOR', and RCOCT₃, as in the previous system. The relatively high yield of ethyl acetate from the systems with ethyl propionate suggests extensive alkyl groups scrambling in the primary oxonium intermediate prior to fragmentations. Formation of methanol as the product from the reaction of CT₃⁺ with ethyl formate is consistent with this hypothesis.

The reaction of CT₃⁺ with the monomeric and dimeric forms of acetic acid (R = CH₃; R' = H) yields predominantly CT₃OH and CH₃COOCT₃, respectively.^{107a} As the molar fraction of the dimer decreases from 0.54 to 0.27, the {CH₃COOCT₃}/CT₃OH} ratio decreases from 2.84 to 1.22. This finding is consistent with the following reaction pattern:

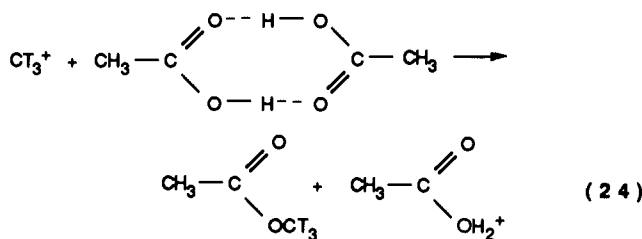
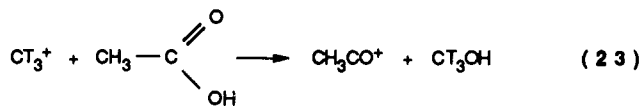

wherein unimolecular fragmentation in the excited oxonium intermediate 26 (R = CH₃, R' = H) from CT₃⁺ ion attack on monomeric acetic acids accounts for the formation of CT₃OH (and CH₃CO⁺)¹¹⁰ (eq 23), whereas, in the excited intermediate from CT₃⁺ ion attack on the dimeric form of acetic acid (eq 24), formation of CH₃COOCT₃ proceeds with the simultaneous transfer of a proton from the attacked molecule to that accompanying it in the dimer. The results concerning the reaction of CT₃⁺ with methyl alkyl ketones RCOR' (R

Table 5. Relative Yields of Main Products from the Gas-Phase Reactions of Methyl Cations with Methyl Alkyl Ketones

substrate	yield (%)				
	labeled substrate	ethane	propene	methanol	acetone
CH ₃ COCH ₃	2 ± 1	20 ± 4	10 ± 3	54 ± 7	2 ± 1
CH ₃ COC ₂ H ₅	2 ± 1	20 ± 5	12 ± 3	49 ± 6	3 ± 1
CH ₃ COC ₃ H ₇	2 ± 1	22 ± 4	13 ± 4	44 ± 5	2 ± 1
CH ₃ COC ₄ H ₉		7 ± 3	3 ± 1	75 ± 10	4 ± 2
CH ₃ CO- <i>i</i> -C ₃ H ₇		6 ± 3	2 ± 1	59 ± 8	7 ± 3
CH ₃ CO- <i>t</i> -C ₄ H ₉	5 ± 2	15 ± 4	10 ± 3	34 ± 7	5 ± 2

= CH₃; R' = CH₃, C₂H₅, C₃H₇, and C₄H₉) are given in Table 5.¹⁰⁶

They point to the formation of a variety of products departing substantially from those indicated in the relevant network of Scheme 5. This marked difference is likely due to the different nature of the oxygen center. In alcohols and esters, the reaction center is connected, either directly in alcohols and esters or through a double bond in esters, to the alkyl structures, whereas in ketones this connection is with the α hydrogens of the alkyl moieties. It follows that the significant yields of methanol from excited 28 of path d of Scheme 5 presumably arises from preliminary 1,3-H transfers, as depicted in eq 25.

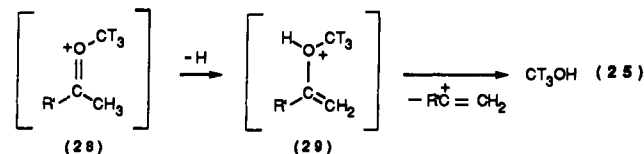

The study of the reactivity of CT₃⁺ toward n-type bases has been extended to hydrogen (RX; R = H, X = Cl, Br, and I) and alkyl halides (RX; R = CH₃ and C₂H₅, X = F, Cl, Br, and I).¹⁰⁸

The results can be summarized as follows. In HX (X = Cl, Br, I; 165–270 Torr), the only labeled product formed is the corresponding methyl halide, CT₃X.^{108a} In CH₃X (X = F, Cl, Br; 660 Torr), only the corresponding CT₃X derivative is recovered in yields ranging from 14% (X = Cl, Br) to 68% (X = F).^{108b} When CT₃⁺ is allowed to decay in equimolar mixtures of CH₃F and CH₃Cl or CH₃F and CH₃Br, the yields of CT₃Cl and, respectively, CT₃Br increase significantly (up to 48%), at the expense of CT₃F, whose yield drops to 30%. In C₂H₅X (X = Cl, Br, I; 135–450 Torr), substantial amounts of both labeled methyl and ethyl halides are recovered whose relative yields depend on the nature of X. Thus, while 100% of CT₃X (X = I) is produced in the C₂H₅I systems, its yield decreases to 37% (X = Br) and 15% (X = Cl), in the corresponding C₂H₅X samples. Such a decrease is counterbalanced by an increase of the relative yield of the labeled ethyl halide [43% (X = Br); 49% (X = Cl)] and by the formation of appreciable quantities of *i*-C₃H₇X [20% (X = Br); 25% (X = Cl)] and *n*-C₃H₇X [11% (X = Cl)].^{108a}

The results have been traced to the formation of stable methylhalonium intermediates, RXCT₃⁺, from the attack of CT₃⁺ on the n-type center of the substrate. This leads, in the CH₃X systems, to the formation of the corresponding CH₃XCT₃⁺ ions. In the competition experiments, intermolecular methyl transfer occurs between the halides, in the direction dictated by the

Table 6. Substrate Reactivity and Isomeric Composition of Products from the Competitive Gas-Phase Methylation of Halobenzenes with Toluene

system composition (Torr)	isomeric composition of products (%)								k_{PhX}/k_{PhCH_3}
	PhX	PhCH ₃	xylenes			halotoluenes			
			<i>ortho</i>	<i>meta</i>	<i>para</i>	<i>ortho</i>	<i>meta</i>	<i>para</i>	
X = F	20	200	25.4	58.4	16.2	35.3	51.4	13.3	0.76
	200	200	25.3	57.8	16.9	42.4	46.6	11.5	0.80
	200	20	23.4	60.9	15.7	39.9	48.7	11.4	0.89
X = Cl	10	100	24.0	61.0	15.0	30.8	56.9	12.3	0.59
	100	100	28.8	54.3	16.9	30.4	57.2	12.4	0.51
	100	10	35.3	47.6	17.1	30.8	56.9	12.3	0.41
X = Br	10	100	25.0	75.0		27.6	52.2	21.2	0.54
	90	90	28.1	71.9		26.6	57.8	15.6	0.41
	90	10	29.6	70.4		27.2	60.1	12.7	0.23

Table 7. Tritiated Products from the Gas-Phase Reactions of CT₃⁺ Decay Ions with Halobenzenes (C₆H₅X, X = F, Cl, Br)

substrate pressure (Torr)	relative activity of products (%)					isomeric composition of the halotoluenes			
	methyl halide	benzene	toluene	halobenzene	halotoluenes	<i>ortho</i>	<i>meta</i>	<i>para</i>	
X = F	100	≤0.1	0.7		49.9	49.3	33.6	57.1	9.3
	400	0.3	0.9		47.3	48.8	41.2	47.4	11.4
X = Cl	30	3.2	2.8	0.8	58.4	34.8	26.8	61.9	11.3
	100	2.9	2.9	0.3	56.4	37.4	29.2	58.2	12.6
X = Br	30	3.3	2.2	11.8	61.3	21.4	21.9	66.5	11.6
	90	3.3	3.1	10.1	58.6	24.9	24.6	64.6	10.8

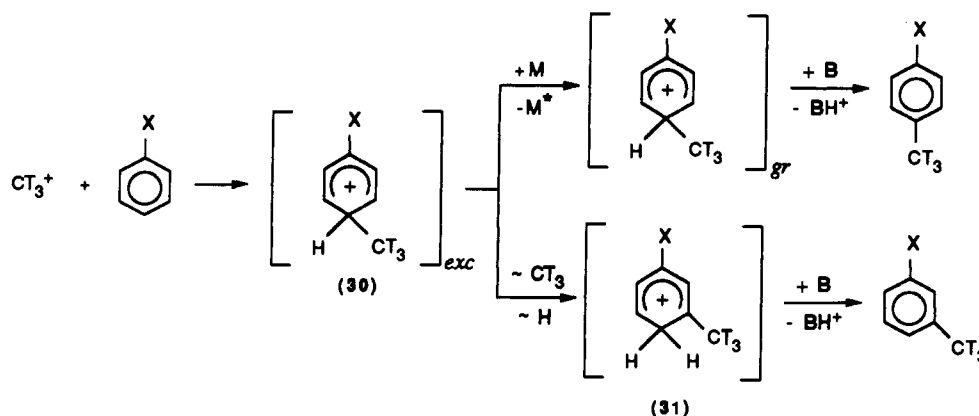
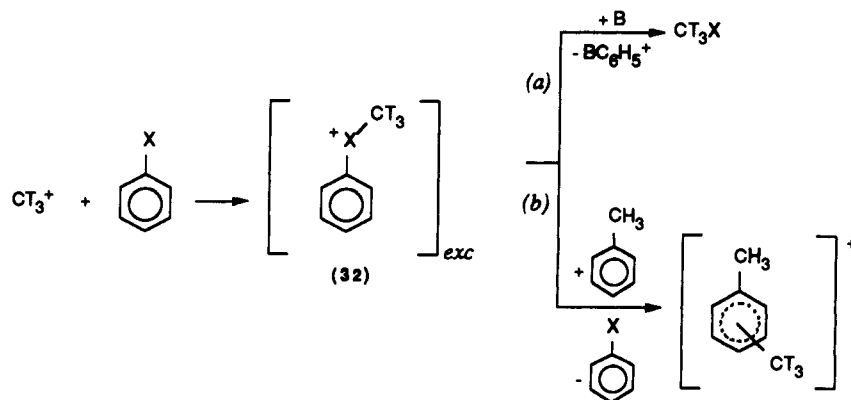
Scheme 11**Scheme 12**

extent of ring methylation depends on the nature of X, increasing in the order Br < Cl < F. The extent of the competing n-methylation, yielding **32** (path a of Scheme 12), increases instead in the opposite order: F ≪ Cl < Br, as shown by the yields of the corresponding halides CT₃X. The CT₃⁺ selectivity toward the n centers of

C₆H₅X has been rationalized in terms of the HSAB principle, in that the reactivity toward the methyl cation, a very soft Lewis acid, increases with the softness of the halogen center, following the order F ≪ Cl < Br.

The effective collisional stabilization typical of the liquid environment allows the isomeric composition of

Scheme 13

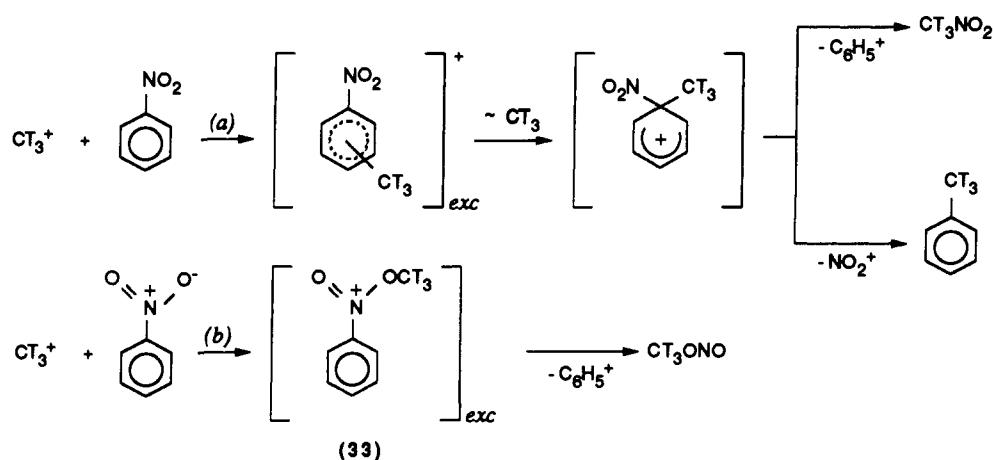

the products to reflect, at least to some extent, the original selectivity of the electrophilic attack to the ring, with a predominant *ortho/para* orientation and a *para/0.5 meta* ratio in excess of 3.

Formation of **32**, which reacts as an effective methylating reagent, (path b of Scheme 12), for example, does not allow the establishment of an accurate reactivity scale of the aromatic ring of halobenzenes toward CT_3^+ . However the approximate rate constant ratios deduced from this study, *i.e.* $k(\text{C}_6\text{H}_5\text{F})/k(\text{C}_6\text{H}_5\text{Cl})/k(\text{C}_6\text{H}_5\text{Br}) = 1.5:1.3:1.0$, are comparable, if somewhat lower, than those measured with strong alkylating reagents of incipient cationic nature in aprotic polar solvents,¹⁷⁴ *e.g.* the $\text{C}_2\text{H}_5\text{Br}-\text{GaBr}_3$ complex in $\text{C}_2\text{H}_4\text{Cl}_2$, giving the ratios $k(\text{C}_6\text{H}_5\text{F})/k(\text{C}_6\text{H}_5\text{Cl})/k(\text{C}_6\text{H}_5\text{Br}) = 2.1:1.6:1.0$.

The comparison shows that the positional and the substrate selectivity of the free, unsolvated CT_3^+ ions are most closely approached by those of conventional reagents that combine a (necessarily incipient) cationic polarization with a state of limited solvation.

A reaction pattern, analogous to that discussed for halobenzenes, applies as well to the attack of CT_3^+ on nitrobenzene.¹¹⁵ Here, the major tritiated products are nitromethane (10%), toluene (55%), and methyl nitrite (35%). The first two products arise from attack of CT_3^+ on the π system of nitrobenzene (according to path a of scheme 13).

The labeled methyl nitrite proceeds instead from direct attack of CT_3^+ on a lone pair of the nitro group, yielding the oxonium intermediate **33**, which dissociates to methyl nitrite and phenylium ion (path b of Scheme 13).

Table 8 reports the results concerning the systems containing alkyl phenyl and alkyl benzyl ethers as the substrates.^{105a} Here also, the nature and the relative yields of the labeled products point to the intermediacy of both oxygen- and ring-methylated intermediates **34** and **35**, respectively (Scheme 14).

Table 9 lists the intramolecular competition factors, which are defined as the ratios of the yields of the products from **34**, *i.e.* CT_3OR and $\text{CT}_3\text{O}(\text{CH}_2)_y\text{C}_6\text{H}_5$, to the yields of the products from **35**, *i.e.* $\text{CT}_3\text{C}_6\text{H}_4(\text{CH}_2)_y\text{OR}$ and $\text{CT}_3\text{C}_6\text{H}_5$, together with those concerning halobenzenes and nitrobenzene. Analysis of Table 9 reveals that in nitrobenzene and halobenzenes, the π system is more reactive than the n electrons toward CT_3^+ . The reverse is true for alkyl phenyl and alkyl benzyl ethers. The observed changes in the relative

Table 8. Yields of Products of the Interaction of Methyl Cations with Aromatic Ethers

substrate	products	relative yield (%)
CH_3OPh	CT_3OCH_3	44 ± 2
	CT_3OPh	36 ± 1
	CT_3Ph	1
	$\text{CT}_3\text{C}_6\text{H}_4\text{OCH}_3$	20 ± 4
$\text{CH}_3\text{OCH}_2\text{Ph}$	CT_3OCH_3	51 ± 4
	$\text{CT}_2\text{OCH}_2\text{Ph}$	7 ± 1
	CT_3Ph	26 ± 5
	$\text{CT}_3\text{C}_6\text{H}_4\text{CH}_2\text{OCH}_3$	15
$\text{C}_2\text{H}_5\text{OCH}_2\text{Ph}$	$\text{CT}_3\text{OC}_2\text{H}_5$	61 ± 3
	$\text{CT}_3\text{OCH}_2\text{Ph}$	3 ± 1
	CT_3Ph	22 ± 4
	$\text{CT}_3\text{C}_6\text{H}_4\text{CH}_2\text{OC}_2\text{H}_5$	14 ± 4
PhOPh	CT_3OPh	100
	$\text{CT}_3\text{OC}_4\text{H}_9$	75 ± 4
	$\text{CT}_3\text{OC}_6\text{H}_4\text{C}_4\text{H}_9$	7 ± 1
$\text{PhOC}_3\text{H}_5^a$	CT_3OPh	46 ± 4
	$\text{CT}_3\text{OC}_3\text{H}_5$	7 ± 4
	$\text{CT}_3\text{C}_6\text{H}_4\text{OC}_3\text{H}_5$	46 ± 5
$\text{PhO-}i\text{-C}_6\text{H}_{11}$	CT_3OPh	81 ± 2
	$\text{CT}_3\text{O-}i\text{-C}_6\text{H}_{11}$	7 ± 3
	$\text{CT}_3\text{C}_6\text{H}_4\text{O-}i\text{-C}_6\text{H}_{11}$	12 ± 5

^a $\text{C}_3\text{H}_5 = \text{allyl}$.

reactivity are attributed to differences in the relative basicities of the nucleophilic centers of the substrate.

A similar study has been carried out on 2,6-dimethylanisole, as the bidentate substrate, using nucleogenic benzyl cation, as the electrophile.¹¹⁶ The reaction is carried out at room temperature by dissolving the precursors of the benzyl cation, side-chain multitritiated toluene, in *n*-hexane, nitromethane, or diethyl ether containing, respectively, 0.2, 0.9, and 1.8 mol % of 2,6-dimethylanisole.

The nucleogenic benzyl cation displays high selectivity toward the n-type center of the substrate, leading to predominant formation of benzyl 2,6-dimethylphenyl ether in *n*-hexane and nitromethane, via the O-benzylated oxonium intermediate. In *n*-hexane, the oxonium intermediate undergoes partial isomerization, yielding the corresponding ring-substituted products (0.5 *meta/para* = 1.3). In diethyl ether, only minor amounts of benzyl 2,6-dimethylphenyl ether (3%) are recovered, the major product formed being benzyl ethyl ether (94%).

Scheme 14

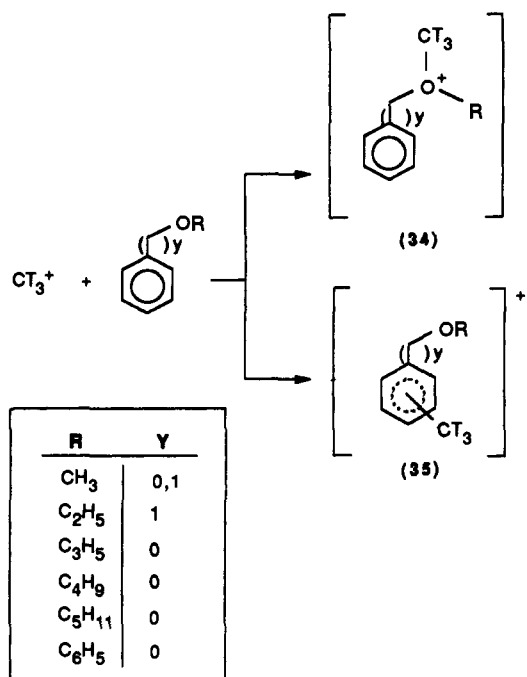
Table 9. Intramolecular Competition Factors in the Gas-Phase Attack of CT₃⁺ Ions on Substituted Benzenes

substrate	<i>n</i> / <i>π</i>
C ₆ H ₅ NO ₂	0.54
C ₆ H ₅ F	0.006
C ₆ H ₅ Cl	0.08
C ₆ H ₅ Br	0.54
C ₃ H ₅ OPh	1.15
CH ₃ OCH ₂ Ph	1.78
CH ₃ OPh	4.00
C ₄ H ₉ OPh	4.55
C ₅ H ₁₁ OPh	7.34
PhOPh	very large

This peculiar behavior of benzyl ion in each individual solvent reveals the profound influence of the medium in determining the actual nature and the properties of the ionic intermediates involved. In the most basic solvent, (C₂H₅)₂O, the formation of benzyl methyl ether indicates that nucleogenic benzyl cation is no longer the actual reactant, it being chemically bound to the oxygen of diethyl ether when attacking the bidentate substrate. In the less basic media, nitromethane and *n*-hexane, the benzyl cation survives in the corresponding solvation shell until it interacts preferentially with the *n* center of the substrate. In the very polar nitromethane, the ensuing oxonium intermediate is stabilized by solvation and survives unchanged until it undergoes bimolecular demethylation by the nucleophiles present in solution. In the apolar *n*-hexane, instead, the oxonium ion is much less solvated and, therefore, it slowly isomerizes intramolecularly to the more stable ring benzylated adducts, in close analogy with the behavior of benzyl phenyl ether when dissolved in chloro- or nitrobenzene in the presence of AlBr₃.¹¹⁷

The favored formation of the *meta* over the *para* benzylated isomer (0.5 *meta/para* = 1.3), despite the higher activation of the *para* position of 2,6-dimethylanisole, points to the intermediacy of a tight "sandwich" π complex in the intramolecular isomerization process, which favors benzyl group transfer from oxygen to the

next accessible unsubstituted ring position, *i.e.* the *meta* positions of 2,6-dimethylanisole, instead of its more activated *para* position. Similarly, occurrence of a three-body, tight "sandwich" π complex, such as aromatic substrate-benzyl halide-metal halide catalyst, in Friedel-Crafts benzylation of 2,6-dimethylphenol and anisole accounts for the predominant *meta* substitution observed in these systems [33–41% (2,6-dimethylphenol); 61–74% (2,6-dimethylanisole)].¹¹⁸ The complete absence of the corresponding O-benzylated products supports this conclusion, by excluding free benzyl cation as the actual reactant in Friedel-Crafts benzylation reactions.

b. Unsaturated Carbenium Ions. Unsaturated carbenium ions are reactive intermediates in which the electron-deficient carbon is an integral part of a π unsaturation. The formally positive carbon atom has a nominally vacant orbital which is orthogonal to a strongly polarized π system.⁷⁸ As a consequence, the positive carbon center tends to acquire the character of a substituted singlet carbene,¹¹⁹ thus conferring on the unsaturated species a marked tendency for insertion into σ bonds and addition to π - and *n*-type electrons.¹²⁰ Of course, such a tendency is modulated by the electronic properties of the groups directly connected to the carbon center. Thus, we can expect a different behavior for the various families of unsaturated carbenium ions, *e.g.* the vinyl **36** (R'CH=C⁺R) and the acyl cations **37** (O=C⁺R) owing to the largely different properties of the CHR' and O moieties bound to the cationic center.

In the following parts, we will present a comprehensive investigation of the intrinsic reactivity features of both ion families carried out by the decay technique.

i. Vinyl Cations with σ Bases. Substituted vinyl cations are now established as reaction intermediates, some of them endowed with fair stability, but positive generation and observation of the unsubstituted vinyl cation **36** (R = R' = H) in reactions in solution has been extremely elusive.^{78,121} In the gas phase, the C₂H₃⁺ ions can easily be produced by mass spectrometric methods and their heat of formation evaluated.¹²² However, very little is known about the reactivity of C₂H₃⁺ ions toward organic substrates and the nature of the ionic intermediates involved. In fact, the gas-phase reactions of C₂H₃⁺ ions with several σ -type nucleophiles, including H₂ and CH₄, have been investigated only by mass spectrometric techniques.¹²³ Special attention was paid in these studies to the effect of internal energy upon the reactivity of the C₂H₃⁺ ion toward H₂ and CH₄. Unavoidably, indeed, the picture obtained in these investigations is incomplete, especially owing to the recognized⁷⁴ limitations of mass spectrometric techniques in the positive structural identification of the ionic species. The picture is further blurred by the occurrence of rapid fragmentation in the excited primary intermediates from addition of C₂H₃⁺ on H₂ and CH₄, owing to their scarce tendency to dissipate their excess energy in the low-pressure source of the spectrometer.

The decay technique has allowed the above limitations to be removed. Thus, C₂H₂T⁺ ions, generated from the β decay of 1,2-C₂H₂T₂,⁴⁷ were allowed to decay in H₂ and CH₄ (60–720 Torr) containing a gaseous nucleophile NuA, *i.e.* 1,4-C₄H₈Br₂, C₆H₆, or CH₃OH.¹²⁴ The latter was used to sample the population of gaseous

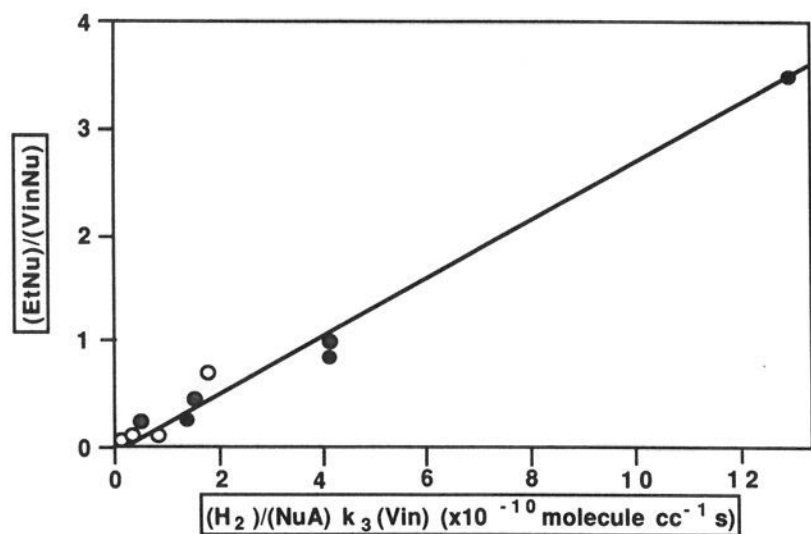
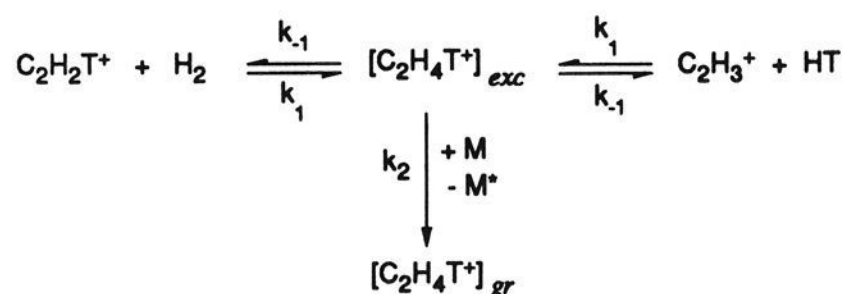

Figure 6. Relative distribution of tritiated EtNu and VinNu products (see text) from the $C_2H_3^+ + H_2$ decay samples as a function of the system composition. [Nu = dibromobutane (black dots), benzene (gray dots), methanol (white dots).]

Scheme 15



cations by fast reactions, yielding products whose structure unequivocally reflects that of the intercepted cation. Thus, in the H_2 systems, addition of $C_2H_2T^+$ leads to formation of excited $C_2H_4T^+$ intermediates, which may undergo collisional stabilization in competition with back-dissociation after H/T scrambling (Scheme 15).

In these systems, therefore, fast reactions of the labeled $C_2H_2T^+$ and $C_2H_4T^+$ ions with NuA lead eventually to the formation of their derivatives, *i.e.* $C_2H_2T^+NuA$ (path a of Scheme 16) and $C_2H_4T^+NuA$ (path b of Scheme 16), whose concentration ratio linearly depends upon the H_2 and NuA partial pressures, as shown in Figure 6.

By estimating k_1 and k_3 with the ADO and AQO approaches,¹²⁵ a value of $(2.8 \pm 0.5) \times 10^{-11} \text{ cm}^3 \text{ molecule}^{-1} \text{ s}^{-1}$ can be obtained for k_2 , which compares well with mass spectrometric measurements,^{120d} pointing to an activation barrier for the addition of $C_2H_3^+$ to H_2 ranging around 9 kcal mol⁻¹.

In the high-pressure CH_4 systems, the highly exothermic addition (a of Scheme 17) which is undetectable by mass spectrometry because of the complete fragmentation (b) of the excited adduct, becomes not only detectable but largely predominant (Figure 7).

Scheme 16

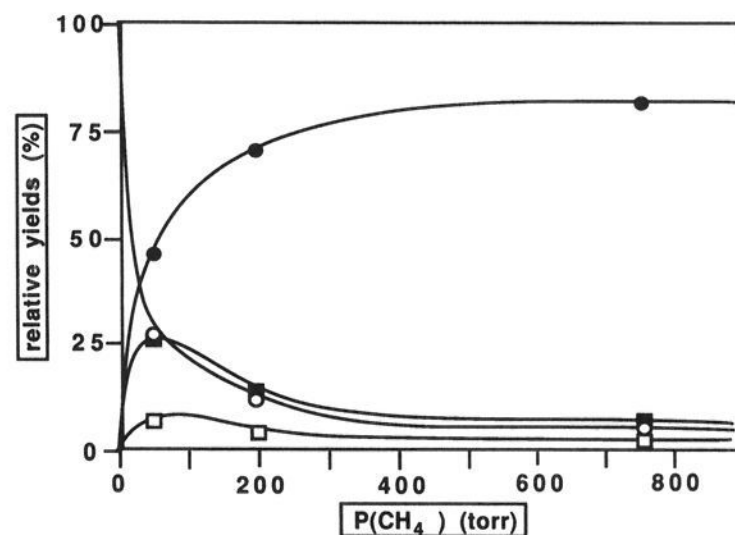
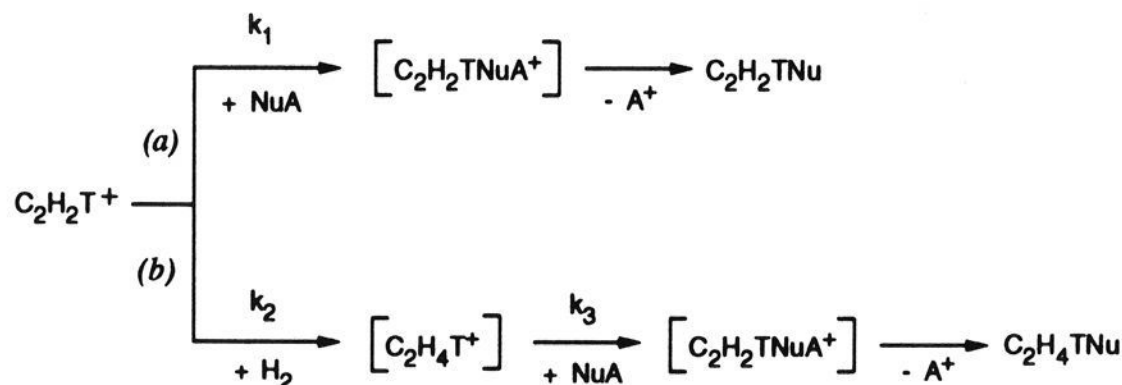
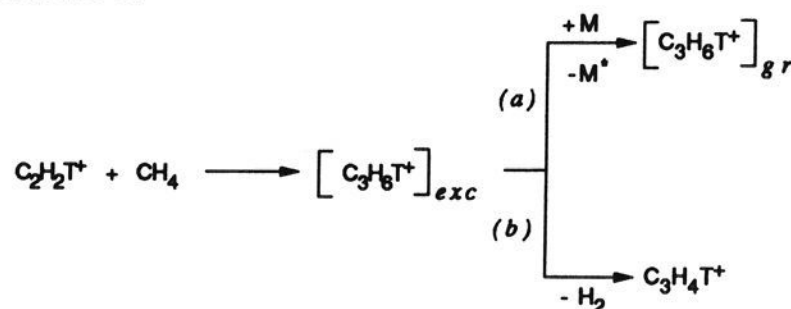

Figure 7. Relative distribution of tritiated products from the $C_2H_3^+ + CH_4$ decay samples as a function of the CH_4 partial pressure: *i*-PrNu (●), allylNu (■), vinylNu (○), *n*-PrNu (□).

Scheme 17



In fact, as the CH_4 pressure is raised, an increasing fraction of the excited adducts is collisionally stabilized (path a of Scheme 17) and survives until trapped by the nucleophilic NuA (eq 27).



As for the H_2 systems, the slope of the curve of Figure 8 provides an estimate of $(5.5 \pm 1.0) \times 10^{-10} \text{ cm}^3 \text{ molecule}^{-1} \text{ s}^{-1}$ for the rate constant of the addition of $C_2H_3^+$ to CH_4 , which is consistent with independent mass spectrometric measurements.¹²³

According to Figure 7, the decay experiments have allowed the detection of vinyl, allyl, and, for the first time, isopropyl and *n*-propyl ions in the CH_4 systems. In fact, the high efficiency of collisional stabilization in the range 60–720 Torr, makes branch b of Scheme 17 negligible. Analysis of Figure 7 demonstrates that most (>90%) of the $C_3H_6T^+$ complexes formed in Scheme 17, which are stabilized by collisional deactivation (path a of Scheme 17), have the isopropyl ion structure when

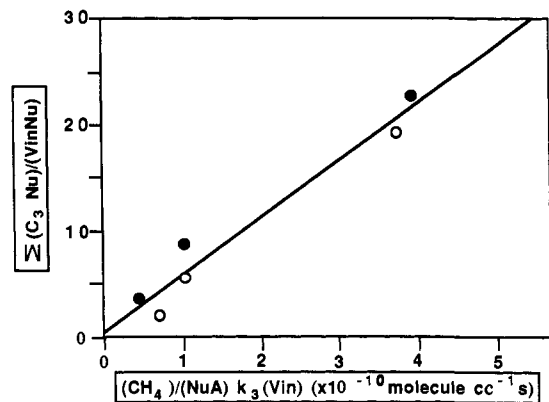

Figure 8. Relative distribution of tritiated C_3Nu and vinylNu products (see text) from the $C_2H_3^+ + CH_4$ decay samples as a function of the system composition. [Nu = benzene (●), methanol (○).]

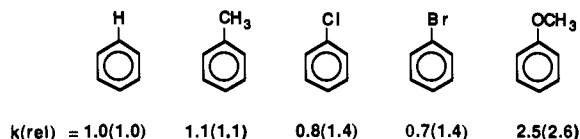

Figure 9. Relative reactivity of substituted benzenes toward nucleogenic vinyl cation. The data refer to competition experiments carried out at room temperature in liquid arenes. The data in parentheses refer to gas-phase competition experiments at room temperature.

trapped by NuA *ca.* 10^{-9} s after their formation. Since vinyl ion insertion into a C–H bond of methane cannot yield $i\text{-}C_3H_6T^+$ without some kind of rearrangement, one can speculate as to whether such structural change involves the intermediacy of a protonated cyclopropane moiety, as suggested by the results of an ion-beam scattering study at energies in the 0.5–3.2-eV range.^{123e} The remarkably low yields of *n*-propyl derivatives, and the lack of $c\text{-}C_3H_5T$ among the products, fail to support this view, at least as long as the formation of a persistent $c\text{-}C_3H_6T^+$ intermediate (lifetime $>10^{-9}$ s) is concerned.

In conclusion, the decay technique has allowed the first *direct* study of the insertion of vinyl ion into σ bonds, such as those of H_2 and CH_4 , unaffected by secondary fragmentation, and the characterization of the charged adducts formed, whose structure could only be speculated upon, on the basis of circumstantial mass spectrometric evidence.

ii. Vinyl Cation with Arenes. The study of the reactivity of unsubstituted vinyl cation has been extended to aromatic substrates, including benzene, toluene, fluorobenzene, chlorobenzene, bromobenzene, and anisole, in both the gaseous and the liquid phase.¹²⁶ The results, reported in Figure 9, obtained in the liquid aromatic substrates, both neat or in competition with benzene, characterize vinyl cation as a typical, if unselective, electrophile. The gas-phase data, instead, point to extensive fragmentation and isomerization of the primary arenium intermediates (38 in Scheme 18), promoted by their large excitation energy arising from the high exothermicity of their formation process ($\Delta H^\circ = -73$ kcal mol⁻¹¹²⁶ in the case of benzene). The decay experiments have provided the only information so far available on the reactivity and the orientation of the otherwise elusive vinyl cation $C_2H_3^+$.

The decay technique has also been applied to the study of the reactivity of free phenylvinyl cations with

Scheme 18

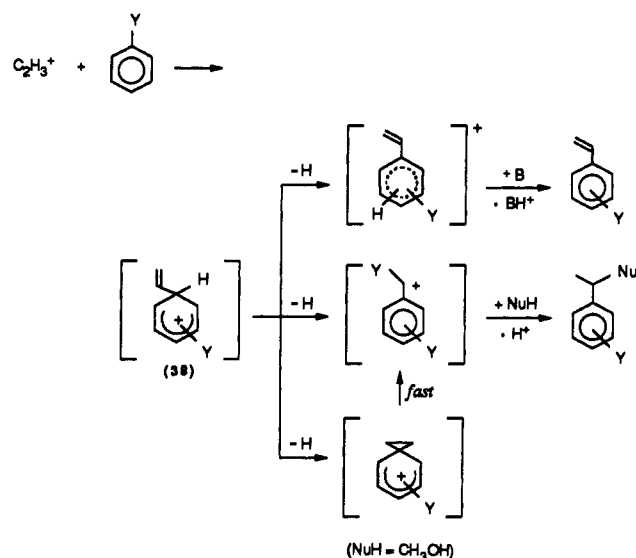

nucleophiles, such as H_2O , C_2H_5OH , $(C_2H_5)_2O$,^{21,127} and benzene,¹²⁸ in various aggregation states. The results are consistent with the reaction networks represented in Scheme 19. Unfortunately, these latter studies have not been carried out under conditions ensuring against radiolytic artifacts, since using activity levels of the multitritiated styrene precursor which exceeded by several orders of magnitude the limit of 100 mCi per mol of bulk gas recommended in part B of section III. Therefore, their results must be used with considerable caution.

iii. Arylium Ions with Alkanes. Singlet phenylium ion 8 is a special unsaturated carbenium ion (36, with $R, R' = -CH=CHCH=CH-$) wherein the formally vacant sp^2 orbital is orthogonal to an aromatic π system. Accordingly, phenylium ion is expected to insert readily into a σ bond and to add efficiently to π - and n -type centers. In the gas phase, these reactivity properties have been tested by using mass spectrometric approaches,¹²⁹ although at the low pressures prevailing in these procedures, high-energy reaction pathways are normally operative. In solution, there is no precise notion on the reactivity of phenylium ion, since a mechanistic ambiguity has long plagued its formation reactions. Aryl cations have in fact been postulated as intermediates in the thermal and photochemical decomposition of arene diazonium salts. However, de-diazonation reactions can follow several pathways involving possible biradical species, aryne intermediates, or one-step bimolecular mechanisms; the elucidation of precise reaction mechanisms and the exact nature of reactive intermediate(s) is therefore very complicated.

In this context, application of the decay technique to investigate the reactivity of arylium ions, including the unsubstituted phenylium ion 8, in both the gaseous and liquid phase proved very fruitful. In a first study, a free tritiated phenylium ion was generated from β decay of 1,4- T_2 -benzene⁴⁶ and allowed to react with gaseous hydrocarbons, *i.e.* CH_4 , C_2H_6 , and C_3H_8 (10–100 Torr), either neat or in competition with nucleophilic acceptors NuH, *i.e.* NH_3 and CH_3OH .¹³⁰ Nucleogenic phenylium ion displays a pronounced tendency to insert readily into the C–H bonds of the selected

Scheme 19

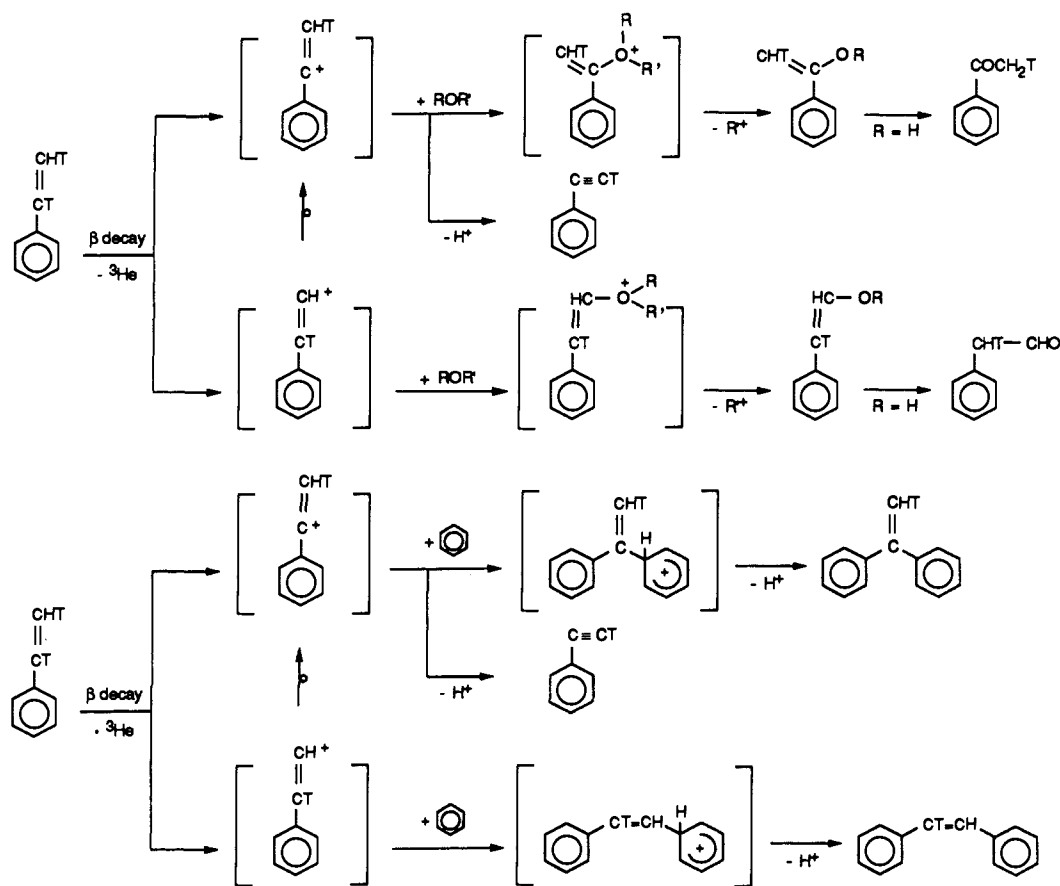

hydrocarbons. In fact, significant yields of tritiated toluene and ethylbenzene are formed in the CH_4 and C_2H_6 systems, respectively. In the C_3H_8 mixtures, both *n*-propyl- and isopropylbenzene are formed, in relative yields depending upon the total pressure, *i.e.* 0.25:1 (10 Torr) or 0.7:1 (100 Torr). Formation of significant amounts of labeled alkylbenzenes in the decay samples confirms the high reactivity of phenylium ion even toward σ -type substrates,¹²⁹ although competition experiments in $\text{CH}_4/\text{CH}_3\text{OH}$ mixtures revealed that the efficiency of the attack of 8 at the C–H bond of CH_4 is only *ca.* one-tenth of that of the oxygen of CH_3OH .

The high reactivity of 8 is accompanied by an apparent, significant site selectivity. Exclusive formation of ethylbenzene in the C_2H_6 systems points to the insertion of 8 only into the $\sigma_{\text{C-H}}$ bonds of the substrate, while any conceivable attack to its $\sigma_{\text{C-C}}$ bond appears ignored.

A similar picture is obtained in the C_3H_8 systems. Here, the predominance (>97.6%) of isomeric propylbenzenes suggests the exceptional selectivity of 8 for the $\sigma_{\text{C-H}}$ bonds of the hydrocarbon over its $\sigma_{\text{C-C}}$ bonds. The apparent site selectivity of 8 is confirmed by its different affinity for the primary and secondary C–H bonds of propane. Indeed, the *n*-propylbenzene/isopropylbenzene yield ratio measured in the C_3H_8 systems at different pressures, *i.e.* 0.25 (10 Torr), 0.7 (100 Torr), is quite different from that expected on a statistical basis, *i.e.* 3. The remarkable, apparent combination of a high reactivity of 8 for σ bases, accompanied by an exceedingly high site selectivity which, *inter alia*, seems to be affected by the total system pressure, poses several questions about the real

nature and the fate of the encounter complexes involved in the C–H bond insertion reaction.

An answer was obtained from the investigation of a strictly related arylum ion, *i.e.* the tolylium ions 12, toward propane under similar experimental conditions.¹³¹ Spontaneous β decay in ring-multitritiated toluene, with a T content of 33% *ortho*, 45% *meta*, and 22% *para*,⁴⁵ leads to the formation of the corresponding isomeric tolylium ions 12 in the same proportions, *i.e.* 33% (12o), 45% (12m), and 22% (12p). As discussed in part g of section IV, owing to their “deformation energy”, nucleogenic tolylium ions undergo intramolecular 1,2-hydride shifts (eq 12), as shown in Figure 5. Making use of the curves of Figure 5, it is possible to estimate the extent of unimolecular isomerization of 12 in the time interval between collisions in gaseous propane at different pressures and, therefore, the isomeric composition of the reactants 12 immediately before their addition to C_3H_8 , *i.e.* 40% (12o), 45% (12m), and 15% (12p) at 100 Torr, and 44% (12o), 45% (12m), and 11% (12p) at 20 Torr. Direct information on the nature of the encounter complexes involved in the attack of 12 on propane arises from the analysis of the isomeric distribution of both *n*-propyl- and isopropyltoluenes formed and its dependence upon the composition of the mixture (Figure 10).

The relative abundance of the *meta* propylated toluenes exceeds that of their ionic precursor 12m (45%) by a factor which increases at low C_3H_8 pressure and in the absence of bases. Of course, the reverse is true with regard to the *ortho* and *para* isomers. These findings are consistent with the occurrence of σ -bonded *ipso*-propylated toluenium isomers 39 from 12, which

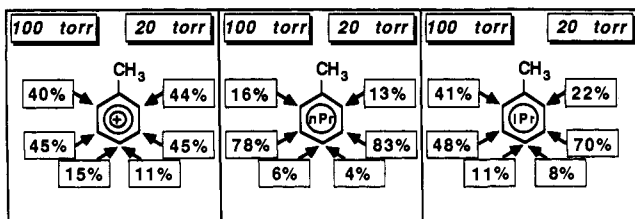

Figure 10. Isomeric distribution of tolylium ions, *n*-propyltoluenes, and isopropyltoluenes at 100 and 20 Torr of propane.

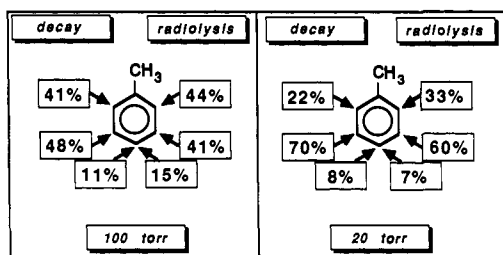
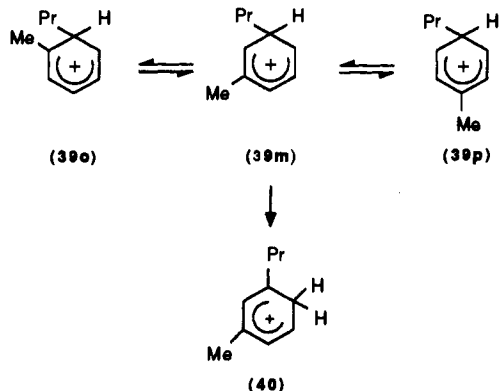

Figure 11. Isomeric distribution of isopropyltoluenes from attack of nucleogenic tolylium ions on propane and of radiolytic isopropyl cations on toluene in gaseous propane at 20–100 Torr.

Scheme 20



undergo partial equilibration in favor of the thermodynamically most stable isomer 40 (Scheme 20).

Closer inspection of Figure 10, however, reveals that, under the same experimental conditions, the relative abundance of the *meta* isomer of *n*-propyltoluene (78–83%) invariably exceeds that of the corresponding isomer of isopropyltoluene (48–70%), in spite of the higher migratory aptitude of the isopropyl group relative to that of *n*-propyl.¹³² This apparent inconsistency is settled by comparing the isomeric composition of the isopropyltoluenes arising from the decay experiments and that obtained from gas-phase attack of radiolytic

Scheme 21

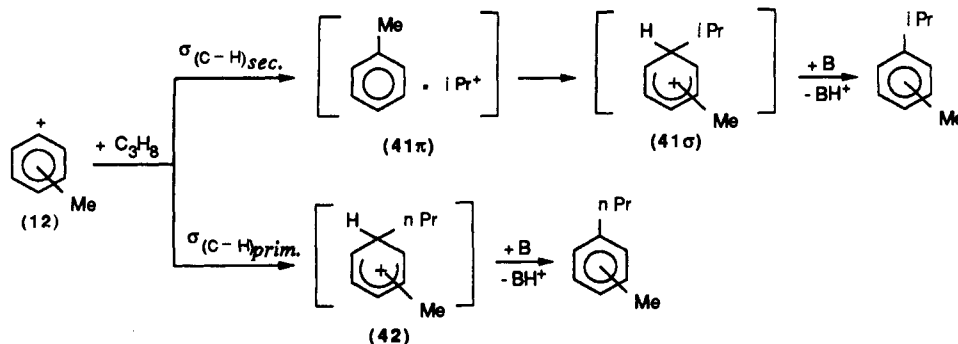

isopropyl cations on toluene, under the same experimental conditions (Figure 11).¹³³

If allowance is made for the slight difference in the energetics of the two sets of experiments, the agreement between the isomeric distributions of Figure 11 appears so good to suggest that both reactions proceed through a common intermediate, *i.e.* via the preliminary electrostatic adduct 41π . It follows that attack of tolylium ions 12 on propane induces a complex reaction pattern (Scheme 21), involving the direct formation of a classical σ -bonded arenium ion 42, when 12 interact with the primary σ_{C-H} bonds of C_3H_8 , or, alternatively, the intermediacy of the electrostatic complex 41π , eventually collapsing to the σ intermediate 41σ , if the interaction intervenes between 12 and the secondary σ_{C-H} of the hydrocarbon.

Following the same reasoning, the combination between the high reactivity of phenylium ion 8 and its apparently high site selectivity toward propane is explained by the occurrence of an electrostatic adduct 44π , similar to 41π , from the transfer of a hydrogen of C_3H_8 to 8, prior to its conversion to the σ intermediate 44σ (Scheme 22). Within 44π , the *n*-propyl moiety acquires a partial positive charge and is able to isomerize to the isopropyl structure (43π in Scheme 22), before collapsing to 44σ .

It is concluded that the apparent site discrimination of 8 toward propane derives from extensive propyl group rearrangement within the electrostatic adducts originated from indiscriminate hydride ion transfers from C_3H_8 to phenylium ion.

Similar rearrangements are frequent in ionic complexes involved in unimolecular ion fragmentation in mass spectrometry.¹³⁴ Therefore, this example provides a caveat against indiscriminate use of fragmentation patterns (MIKES, CID, CA, etc.) as probes for ion-structure analysis in mass spectrometry, without the necessary, detailed evaluation of the extent and the mechanism of all the isomerization pathways accessible to the ionic species under investigation within the comparatively large time lag (10^{-6} – 10^{-5} s) between its formation and its structural assay.

iv. Phenylium Ions with Unsaturated Hydrocarbons. A substantial fraction of the applications of the decay technique refers to the investigation of the reactivity of phenylium ion toward unsaturated hydrocarbons. A number of alkenes and arenes have been employed in these studies, including acetylene,¹³⁵ ethylene,^{126a} propene and cyclopropane,¹³⁶ 1,3-butadiene,¹³⁷ alkylbenzenes,¹³⁸ and five-membered heteroaromatics.¹³⁹

Scheme 22

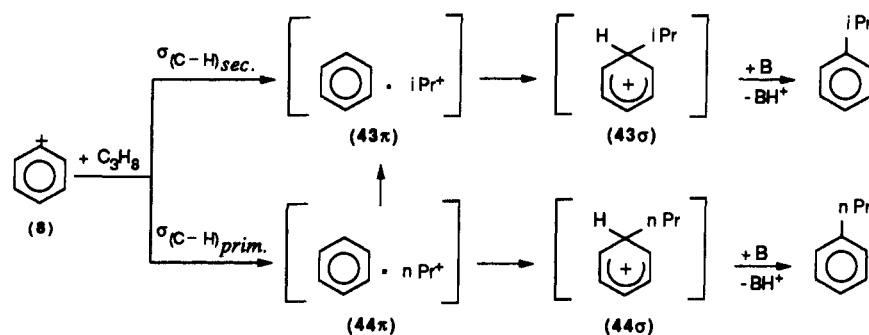

Scheme 23

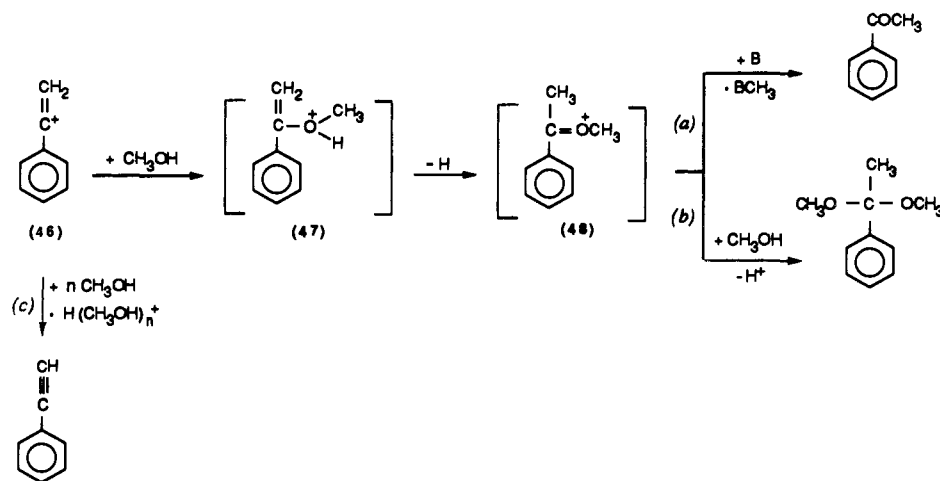

A first investigation of the reactivity of phenylium ions toward π bonds was stimulated by the observation that, despite its high reactivity toward virtually all organic compounds,¹²⁹ the C_6H_5^+ ion, having the cyclic phenylium ion structure, was found unreactive toward acetylene under low-pressure ICR conditions (10^{-6} – 10^{-5} Torr).¹⁴⁰ This finding is of great interest to the chemistry of soot formation in fuel-rich acetylenic flames. The discrepancy between such a conclusion and the proven reactivity of phenylium ion in the gas phase prompted application of the nuclear-decay approach to the problem.

Multitritiated benzene⁴⁶ was allowed to decay at room temperature in gaseous 2.8:1 or 1:2.3 $\text{C}_2\text{H}_2/\text{CH}_3\text{OH}$ mixtures at total pressures of 100 Torr.¹³⁵ Apart from tritiated anisole, which is the major product (50–86%) arising from direct attack of 8 on CH_3OH , several other minor products were recovered, including acetophenone (9–41%), and its acetal (2–3%), and phenylacetylene (3–6%). Formation of these latter compounds requires addition of the phenylium ion 8 to the acetylene triple bond, yielding a primary adduct 45 (eq 29) which

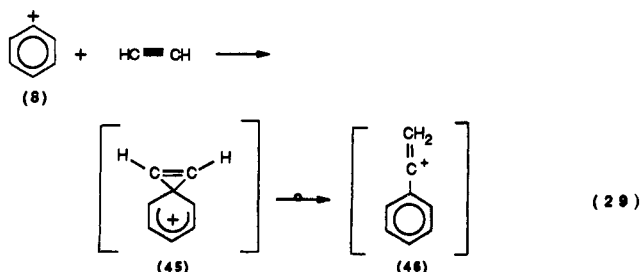

isomerizes to the much more stable α -phenylvinyl cation structure 46 before reacting with methanol.

Direct interaction of 46 with CH_3OH leads to the oxygen-protonated enol ether 47, which may either lose a methyl group, yielding acetophenone (path a of Scheme 23), or add another methanol molecule, giving rise eventually to its acetal (path b of Scheme 23). Alternatively, loss of an acidic β proton from 46 to a cluster of CH_3OH molecules accounts for the formation of tritiated phenyl acetylene (path c of Scheme 23).

With regard to a quantitative estimate of the phenylium ion reactivity toward acetylene, the results of the $\text{C}_2\text{H}_2/\text{CH}_3\text{OH}$ competition experiments indicate that the efficiency of the attack of gaseous 8 to acetylene approaches unity under the experimental conditions adopted. Such a conclusion completely contrasts with that of the ICR experiments.¹⁴⁰ A rationale for this discrepancy is found in the largely different pressure regimes operative in the ICR (10^{-6} Torr) and in the nuclear-decay experiments (100 Torr). At 100 Torr, survival of the addition complexes in eq 29, is favored by collisional quenching, which rapidly removes the excess energy from their highly exothermic formation reaction ($-\Delta H^\circ = 54$ – 86 kcal mol⁻¹). At 10^{-6} Torr, unimolecular fragmentation of the adducts in eq 29 represents the only way, apart from unlikely radiative emission, for dissipating their excess energy. Since the energetically most accessible fragmentation path of the adducts in eq 29 involves their back-dissociation into 8 and C_2H_2 , the efficiency of the addition in eq 29 decreases significantly with the pressure becoming negligible under ICR conditions.

These experiments provide an additional demonstration of the role of environmental factors in determining the efficiency of gas-phase ionic reactions and warn against generalization of low-pressure mass spec-

trometric data as representative of ionic processes normally occurring at atmospheric pressures, such as those involved in flames.

Similar conclusions were reached in a related investigation of the reactivity of phenylium ion **8** toward ethylene.^{126a} Competition experiments, carried out in 12.5:1 C₂H₄/CH₃OH gaseous mixtures at ca. 60 Torr total pressure, led to a $k(\text{C}_2\text{H}_4)/k(\text{CH}_3\text{OH})$ rate constant ratio of ca. 0.5 for nucleogenic phenylium ion **8**, in good agreement with the previous estimates for acetylene. Predominant formation of α -methoxyphenylethane (82%), together with styrene (4%) and anisole (14%), implies the addition of **8** to the π bond of ethylene, yielding the primary adduct **48** (eq 30), rapidly rearranging to the thermodynamically more stable isomer **49**, before being trapped by CH₃OH, in analogy with eq 29.

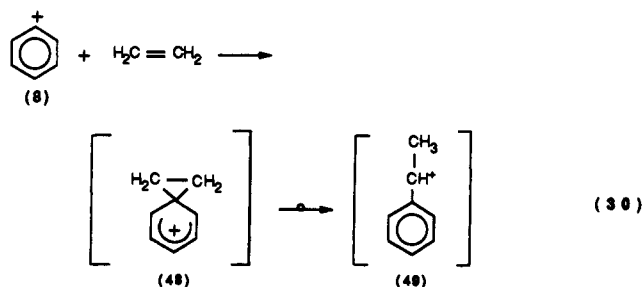

The study of the reactivity of nucleogenic phenylium ion **8** has been extended to gaseous C₃H₆ hydrocarbons as well.¹³⁶ Both propene and cyclopropane were used as gaseous substrates, at pressures ranging from 10 to 700 Torr. Phenylium ion attacks efficiency both the C-H and the C-C bonds of cyclopropane, yielding respectively tritiated cyclopropylbenzene (29–46%) and indan (6–55%), as major products. Formation of the latter products involves the intermediacy of the spiroarenium ion **50** (eq 31), wherein relief of the strain energy in the cycloaliphatic moiety promotes intramolecular 1,2-CH₂ shift over the aromatic ring, yielding eventually the intermediate **51**, which deprotonates to indan.

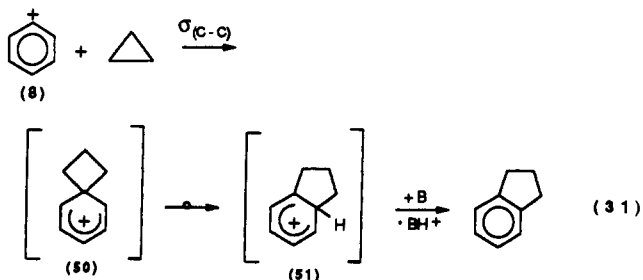

The reactivity pattern prevailing in propene differs substantially from that observed in gaseous cyclopropane. First, the much lower product yields (5 vs 40%) of the labeled aromatic products recovered from the propene systems indicate the occurrence of much more extensive secondary processes, e.g. hydride ion abstraction, cationic polymerization, etc. Second, the isomeric composition of the aromatic products, dominated by *trans*- β -methylstyrene (47–50%), with minor amounts of the α -methylstyrene (20–22%), isopropylbenzene (14–23%), and allylbenzene (10–14%), is found unaffected by the total pressure. Phenylium ion attacks preferentially the π system of propene yielding the spiro-

arenium intermediate **52** (eq 32), which gives eventually the labeled aromatic products by H⁺ loss to or H⁻ uptake from a suitable molecule.

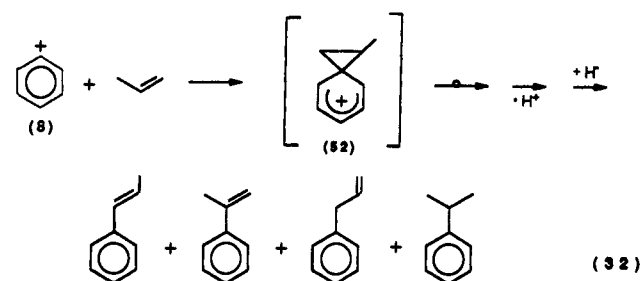

As a final consideration, it should be mentioned that, while phenylium ion attacks both the C-H and the C-C bonds of cyclopropane, it displays a distinct preference for the π bond of propene over its σ -type centers, both the C-H and C-C bonds, as shown by the relatively low yields of allylbenzene (10–14%) and by the exclusive formation of the *trans* isomer of β -methylstyrene.



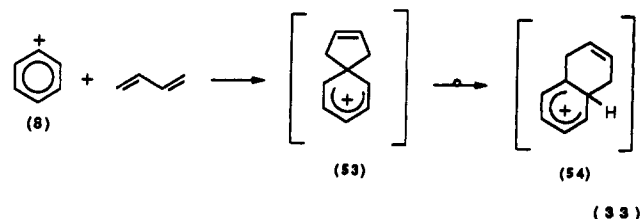



Addition reactions of carbocations to conjugated dienes have seldom been explored, due to the inherent properties of Friedel-Crafts catalysts and reagents in inducing cationic polymerization.¹⁴¹ In the gas-phase study of the reactivity of nucleogenic phenylium ion **8** toward 1,3-butadiene, these limitations are less stringent.¹³⁷ When the reaction is carried out in neat 1,3-butadiene (10–30 Torr) or in He/C₄H₆ 720:10 Torr mixtures, only tritiated naphthalene is recovered in very low absolute yields (2–3%). This is due to the extensive cationic polymerization initiated by attack of **8** on C₄H₆ and propagated by their secondary adduct ions. These ions, which represent the chain carriers, can however be trapped by rapid proton transfer when a powerful base, such as trimethylamine, is added to the system in appreciable concentrations (5 Torr). Under these conditions, in fact, naphthalene, whose absolute yield increases to 9%, is accompanied by *trans*-1-phenyl-1,3-butadiene (4%), 1,2-dihydronaphthalene (3%), 1,4-dihydronaphthalene (4%), and 3-methylindene (4%). The nature of these tritiated products points to a preferred attack of **8** at the terminal carbon atom of the conjugated diene, in agreement with related solution data. The reaction is thought to proceed via the spiro intermediate **53** (eq 33) in compliance with the carbene-like nature of **8**.



In analogy with eq 31, the spiro intermediate **53** isomerizes to the more stable isomer **54**, prior to being neutralized by NMe₃. This, in turn, may follow several competing pathways, including ring opening, hydrogen-atom shifts, H₂ elimination, proton transfer to a base, etc., as shown in Scheme 24.

The formation of 3-methylindene is traced to the tendency of cyclohexyl ions, such as **55**, to undergo ring

Table 11. Product Distributions and Apparent Rate Constant Ratios from Attack of Phenylum Ions toward Gaseous Alkylbenzenes

system composition		relative product yields (%)							$(k_R + k_Y)/k_B$	k_R/k_B
$k_Y \rightarrow$	$k_B \rightarrow$									
				<i>o</i>	<i>m</i>	<i>p</i>				
$Y = \text{CH}_3$	no	7	13	27	39	14				
$Y = \text{C}_2\text{H}_5$	no	12	12	19	38	15	4			
$Y = i\text{-C}_3\text{H}_7$	no	18	13	10	38	18		4		
$Y = \text{CH}_3$	yes	38	9	18	26	9		2.0 (1.6) ^a	1.6 (0.7) ^a	
$Y = \text{C}_2\text{H}_5$	yes	44	4	12	24	10	3	1.8	1.3	
$Y = i\text{-C}_3\text{H}_7$	yes	50	7	6	23	11		1.6	1.0	

^a $T = 100^\circ\text{C}$.

intermediate from attack of 8 on the ring of the alkylbenzene, occurring in the liquid phase at room temperature.

When, in fact, the same reaction is carried out in the gas phase, at room temperature, the product pattern is characterized by a substrate selectivity, which parallels that measured in the condensed phase, but accompanied by a distribution of the isomeric alkylbiphenyl, wherein the *meta* isomers predominate (Table 11).^{139a-c} This is attributed to the irreversible attack of phenylum ion on the alkylbenzene ring, yielding a primary arenium intermediate 58 (eq 35), which is excited by the exothermicity of its formation process ($-\Delta H^\circ > 77 \text{ kcal mol}^{-1}$) and, thus, undergoes intramolecular phenyl group shifts to reach the thermodynamically most stable structure 59.

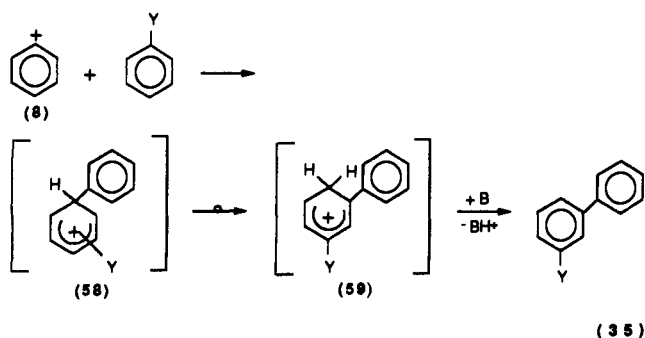

This extensive isomerization process, which is accompanied by other high-energy reactions, *e.g.* phenyldealkylation, indicates that the product distributions of Table 11 are thermodynamically controlled, and thus, no kinetic significance can be attached to them.^{136a,b}

The nuclear-decay data concerning the liquid systems closely parallel those of solution-chemistry studies on related phenylation process, carried out at 60–66 °C using benzenediazonium tetrafluoroborate as the source of phenylum ion.¹⁴³ A most intriguing difference is provided by the $f_m \geq 1.0$ values measured for toluene (Table 10) at 25 °C, which contrast with those < 1.0 ($f_m = 0.43$,^{143a} 0.85^{143b}), measured at 60–66 °C. The $f_m \geq 1.0$ values measured in the decay experiments are consistent with theoretical predictions and rule out previous explanations advanced to account for the $f_m < 1.0$ measured in tetrafluoroborate solutions,¹⁴³ such as a I_π effect in the aromatic,¹⁴⁴ the occurrence of a

spirocyclopropane phenonium ion from insertion of a diradical phenylum ion to an aromatic "double bond",¹⁴⁵ or a nonstatistical distribution of the competing arenes in the liquid cage surrounding the phenylating reactant. In the light of the nuclear-decay data, the most likely explanation for the $f_m < 1.0$ values measured in classical aromatic phenylation in solution¹⁴³ is found in a differential complexing ability of the competing aromatics by the BF_3 acid, liberated in the decomposition of the benzenediazonium salt,¹⁴³ which, by modifying the relative proportions of uncomplexed arenes in the vicinity of the reagent ion, provides *apparent* rate constant ratios unrelated to the intrinsic reactivity scale.

As just shown, the application of the decay technique to electrophilic aromatic phenylation proved of value in estimating the intrinsic reactivity and selectivity of phenylum ions and, by comparison with related phenylation reactions in solution, in recognizing some of the factors superimposing and modifying them in classical solution experiments. A similar approach has been employed to evaluate the intrinsic reactivity of heteroaromatic substrates toward several nucleogenic ions, including the phenylum ions, in gaseous and liquid phase (see part ii of section IV.B.a).





Phenylum ion 8, obtained from the β decay of 1,4- T_2 -benzene, was allowed to react with pyrrole, *N*-methylpyrrole, furan, and thiophene, in both the gaseous and liquid phase, at room temperature.¹³⁹

The relevant experimental results are reported in Tables 12 and 13.

In all systems investigated, the major products are the phenylated substrates. In analogy with the results of the related CT_3^+ experiments (part ii of section IV.B.a), their absolute yield decreases appreciably in the order: pyrrole \approx *N*-methylpyrrole $>$ thiophene $>$ furan. As for CT_3^+ , this trend is accounted for by unproductive attack of the electrophile at the heteroatom of furan and thiophene, efficiently competing with their π systems (see part vi of this section).





According to the preferred attack at the α carbons of all the selected heteroarenes, the nucleogenic phenylum ion is ranked as a soft electrophile, much like CT_3^+ , rather than as a hard one, *e.g.* C_2H_5^+ , $i\text{-C}_3\text{H}_7^+$, and $t\text{-C}_4\text{H}_9^+$, which instead show opposite site selectivities. The behavior of phenylum ion toward pyrroles, typical of a soft electrophile, does not find any correspondence with its STO-3G calculated LUMO energy

Table 12. Tritiated Products from the Attack of Phenylum Ions on Liquid Heteroarenes

Y	system composition (mmol) ^a		tritiated product distribution (%) ^b				apparent rate constant ratio: k_a/k_R	total absolute yield (%)
	(S)	(R)						
NH	3.1	3.1	67.6 (81.2)	14.6 (17.5)	1.1 (1.3)	16.7	4.9	98.6
NMe	3.1	3.1	81.4 (88.1)	11.0 (11.9)		7.6	12.0	96.7
O	2.9	2.9	31.5 (84.0)	6.0 (16.0)		62.5	0.6	66.9
S	2.7	2.7	47.8 (77.3)	14.1 (22.8)		38.1	1.6	72.1

^a All systems contained ca. 1 mCi of 1,4-ditritiobenzene. ^b Ratio of the activity of each product to the combined activity of all products identified. Relative composition of phenylated heteroarenes given in parentheses. Each value is the average of several determinations, with an uncertainty level of ca. 5%.

Table 13. Tritiated Products from the Attack of Phenylum Ions on Gaseous Heteroarenes

Y	system composition ^a (Torr)			tritiated product distribution (%) ^b				apparent rate constant ratio: k_R/k_S	total absolute yield (%)
	(S)	(R)	base						
NH	4.6	5.1		43.5(67.5)	20.0(31.0)	1.0(1.5)	35.6	2.0	89.2
NH	4.7	25.2		16.4(65.2)	8.3(33.2)	0.4(1.6)	74.9	1.8	93.6
NH	4.8	39.8		14.4(66.6)	6.3(29.1)	0.9(1.6)	78.3	2.3	97.8
NH	4.4	11.3	10(NH ₃)	32.0(68.7)	13.2(28.3)	1.4(3.0)	53.4	2.2	30.7
NH	4.8	8.9	10(NMe ₃)	38.6(72.5)	14.6(27.4)	1.1(2.0)	45.7	2.2	26.7
NMe	5.6	3.3		71.3(77.0)	21.3(23.0)		7.4	7.2	79.3
NMe	4.6	28.6		40.0(76.5)	12.3(23.5)		47.7	6.8	90.4
NMe	5.2	14.0	10(NMe ₃)	54.4(75.0)	18.1(25.0)		27.5	7.2	30.4
O	18.7	3.4		4.2(73.1)	1.5(26.9)		93.4	0.01 ₁	8.9
O	88.0	42.1		1.3(73.5)	0.5(26.5)		98.3	0.00 ₈	47.0
O	8.5	32.9		0.0 ₇ (70)	0.0 ₃ (30)		99.9	0.00 ₄	86.1
O	110.0	3.0	10(NH ₃)	20.0(88.3)	2.7(11.7)		77.3	0.00 ₈	7.6
O	12.0	4.5	10(NMe ₃)	2.32(88.5)	0.3(11.5)		97.4	0.01 ₁	1.3
S	10.8	3.2		47.6(65.2)	25.4(34.8)		27.0	0.8	85.4
S	83.0	8.0		59.2(67.4)	28.6(32.6)		12.1	0.7	94.3
S	15.5	8.0	10(NMe ₃)	42.4(70.3)	17.9(29.7)		39.7	1.0	24.6

^a All systems contained ca. 1.2–2.2 mCi of 1,4-ditritiobenzene and 4 Torr of oxygen. ^b See footnote b of Table 12.

ranging between -3.5 eV (ground-state singlet configuration) and -5.5 eV (relative to a nucleogenic singlet phenylum ion with the same regular structure of the benzene precursor), which would rather confer to the ionic reactant a borderline character lying between that of the soft CT_3^+ and the very hard $i-C_3H_7^+$ ion.

Such a discrepancy started a lively debate about the general applicability of the charge and frontier orbital control concept⁹⁸ to the gas-phase electrophilic substitution on heteroarenes by ionic reactants,¹⁴⁶ which eventually led to the conclusion that heteroaromatic reactivity can be satisfactorily treated within the more general curve crossing model.¹⁴⁷

v. Phenylum Ions with n-Bases. The highly efficient addition of phenylum ion 8 to the n electrons of CH_3X ($X = OH, F, Cl,$ and Br) has been previously utilized as a clock for measuring the automerization rate in *p*-T-phenylum ion from the decay of 1,4- T_2 -benzene (part f of section IV.A). The exceedingly high affinity of 8 for the n center of CH_3X contrasts with its scarce tendency to interact with the σ bonds of the substrate.^{66,69}

In this connection, comparison of the product distribution obtained in gaseous CH_3OH with that from the liquid samples discloses an intriguing peculiarity

which is related to the dynamics of the attack of 8 to the nucleophilic centers of methanol (Figure 3). In fact, in liquid CH_3OH , the absolute yield of toluene and benzyl alcohol, arising from attack of 8 to the σ -type centers of the substrate, are invariably higher than those measured in the gas phase. This increase is not accompanied by a similar increase of the absolute yield of anisole, which arises from attack of 8 to the n-type site of methanol. This behavior reflects the preferential solvation of 1,4- T_2 -benzene by the methyl moiety of methanol in liquid phase. Following the almost instantaneous decay event, rotational relaxation of the methanol molecules formerly solvating 1,4- T_2 -benzene is probably too slow to form an organized solvent shell around 8 by directing the oxygen atom, which represents the negative end of their dipole, toward the positive charge of the ion, before the reaction with the ion itself. Therefore, in liquid CH_3OH , the probability of attack on the CH_3 moiety of the solvent by 8 increases relative to the gas phase, where the CH_3OH molecules have enough time to undergo rotational relaxation before reacting with the ion. Reorientation periods of the molecules in liquid CH_3OH being of the order of a few picoseconds, the reaction of 8 with the CH_3 group of CH_3OH is estimated to occur within the same time scale.

Scheme 25

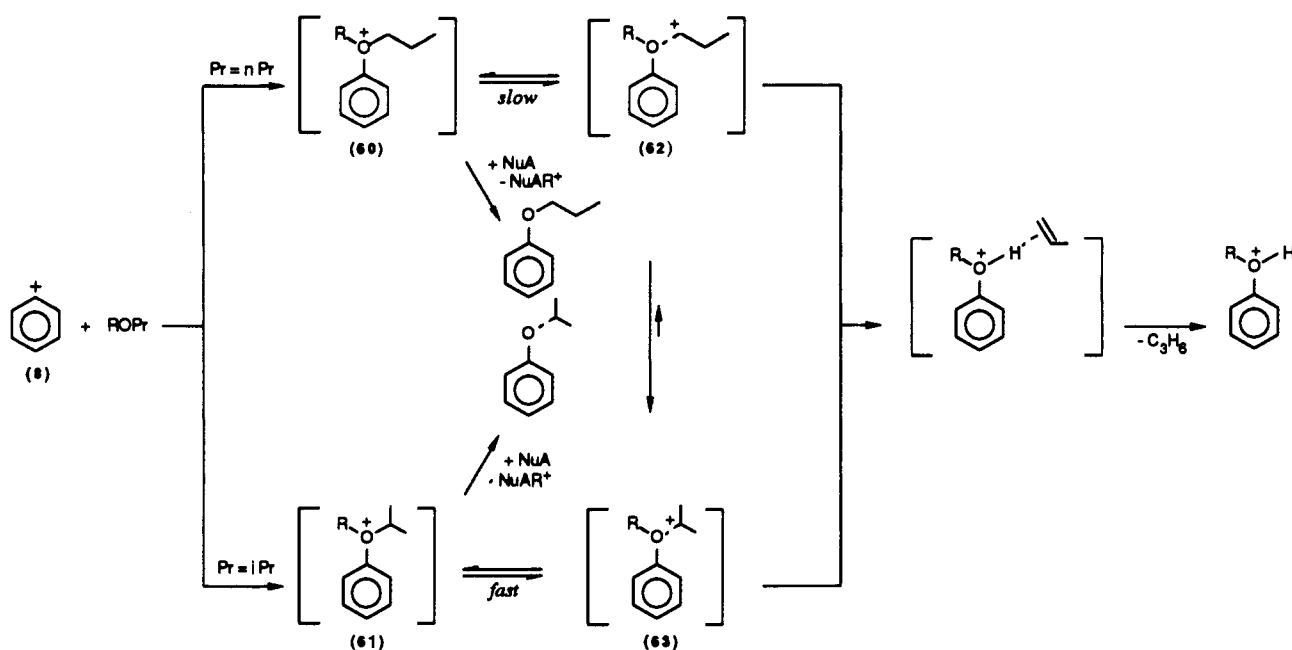

The evaluation of the site selectivity of phenylium ion toward gaseous substrate containing both *n*- and σ -type reaction centers, was extended to alcohols, such as C₂H₅OH, *n*- and *i*-C₃H₇OH, and CF₃CH₂OH, and alkyl chlorides, such as *n*- and *i*-C₃H₇Cl, and *n*-C₄H₉Cl, where the ratio of the σ - and *n*-type sites is progressively increased.¹⁴⁸

Nucleogenic phenylium ion confirms its apparent site selectivity by attacking preferentially the *n* center of the substrate (46–100%), although appreciable insertion into the alkyl group of alcohols is observed as well. Phenylium ion displays significant positional selectivity even between the two different *n* centers of CF₃CH₂OH. Taking into account statistical factors, a k_O/k_F ratio of *ca.* 10 is estimated for the attack of 8 on the O and F atoms of CF₃CH₂OH. The experimental data point to a site selectivity trend F < O < Cl for 8, which indicates a direct relationship between the polarizability of the *n* site of the molecule and its orienting properties toward the ionic reactant.

When, instead of alcohols and alkyl halides aliphatic ethers ROR', with R,R' = CH₃, *n*-C₃H₇; CH₃, *i*-C₃H₇; *n*-C₃H₇, *i*-C₃H₇, are used as substrates, a similar site selectivity was observed, in spite of the increased ratio between the σ - and *n*-type reaction centers.¹⁴⁹ Thus, *ca.* 80% of the interactions between phenylium ion and CH₃OC₃H₇ take place at the O center.

The fate of the oxonium intermediates deriving from addition of phenylium ion to the oxygen of ROR' is highly sensitive to the nature of the R and R' groups and to the reaction conditions. When R = CH₃ and R' = *n*-C₃H₇, formation of anisole is favored at low ether concentrations and in the absence of a powerful nucleophile, such as NH₃. Under the same conditions, appreciable amounts of C₆H₅O-*i*-C₃H₇ is formed as well. Formation of C₆H₅O-*n*-C₃H₇ is instead favored in the presence of high concentrations of nucleophiles NuA, either NH₃ and the ROR' ether itself. In R = CH₃ and R' = *i*-C₃H₇, instead, anisole is the predominant product, accompanied by only very minor amounts of C₆H₅O-*i*-C₃H₇ (0–2%). No formation of C₆H₅O-*n*-C₃H₇ was

observed. The product distribution is insensitive to the system composition.

These observations are consistent with the reaction network depicted in Scheme 25. That formation of anisole involves unimolecular fragmentation of 60 and 61, rather than bimolecular attack of NuA at the α centers of propyl groups, it is demonstrated by the results obtained in the *i*-C₃H₇O-*n*-C₃H₇ systems. Here, a considerable yield of C₆H₅O-*n*-C₃H₇, which places it among the major products (32–34%), is counterbalanced by the total absence of C₆H₅O-*i*-C₃H₇. This is compatible only with unimolecular fragmentation of 60 and 61; the latter fragmentation is much faster than the first one owing to the greater tendency of *i*-C₃H₇, relative to *n*-C₃H₇, to assume a partial positive charge in the complexes 62 and 63. In fact, any significant bimolecular contribution by *i*-C₃H₇O-*n*-C₃H₇ to the dealkylation process would favor formation of the C₆H₅O-*i*-C₃H₇, rather than C₆H₅O-*n*-C₃H₇, on account of the more hindered and less activated C α center of the *i*-C₃H₇ group with respect to *n*-C₃H₇.

The fragmentation pattern of Scheme 25, based on the detailed analysis of the product distribution as a function of the experimental conditions, diverges substantially from that proposed in a related nuclear-decay investigation of the same processes.¹⁵⁰ In this study, formation of anisole and alkyl phenyl ethers is attributed to intervention of a unimolecular fragmentation of the oxonium intermediate, *e.g.* 60 or 61, to R⁺ = CH₃⁺ or C₃H₇⁺ and the ethereal counterpart, in proportions depending on the thermodynamic stability of the carbocation formed. This mechanism contrasts not only with the conclusions summarized in Scheme 25 but also with the endothermicity of the unimolecular CH₃⁺ loss from 60 and 61 ($\Delta H^\circ = 36$ kcal mol⁻¹) and with the recognized tendency of oxonium ions to lose alkyl group as neutral alkene moieties, leaving the positive charge on the ethereal fragment.¹³⁴

The study of the reactivity of phenylium ion toward aliphatic ethers has been extended to cyclic ethers as well.¹⁵¹ Thus, the nucleogenic phenylium ion was allowed

Scheme 26

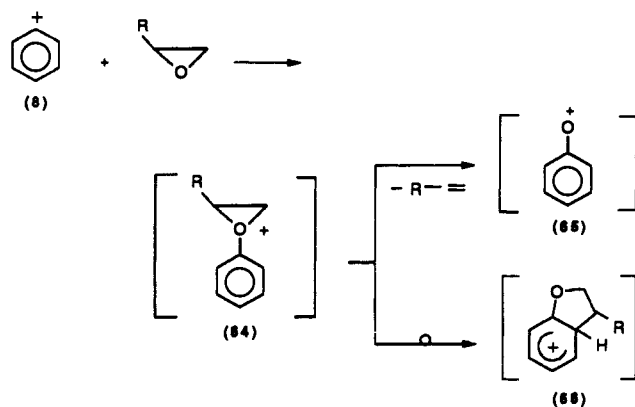

to react with gaseous oxirane, propene oxide, oxetane, and, for comparison purposes, acetaldehyde in the pressure range 30–250 Torr at room temperature. The effects of a gaseous base ($\text{N}(\text{CH}_3)_3$, 20 Torr) and of an energy moderator (He, 630–720 Torr) was also investigated.

Five different classes of aromatic products are recovered from these experiments, *e.g.* dihydrobenzofuran derivatives, benzodioxane derivatives, phenol, benzaldehyde, and acyclic alkenyl phenyl ethers. While the first two families of products predominate in the oxirane and propene oxide decay systems, they are absent in the oxetane and acetaldehyde experiments. Here, phenol is the predominant product. Acyclic alkenyl phenyl ethers are formed in almost all systems, especially in the presence of $\text{N}(\text{CH}_3)_3$. This latter effect reflects the action of the amine as an efficient inhibitor of secondary cationic polymerization chains taking place in all systems.

The product patterns and their sensitivity to the reaction conditions are consistent with the reaction network reported in Scheme 26.

In oxirane ($\text{R} = \text{H}$) and propene oxide ($\text{R} = \text{CH}_3$), predominant attack of 8 to the oxygen center (82–100%) yields the primary oxonium intermediate 64, excited by the exothermicity of its formation process ($-\Delta H^\circ = \text{ca. } 100 \text{ kcal mol}^{-1}$). By virtue of their internal energy excess, oxonium ions 64 undergo fragmentation to the phenoxenium ion (65) and the alkene $\text{RCH} = \text{CH}_2$ in competition with intramolecular isomerization to 66, with the first pathway favored at low pressure relative to the latter one.

Neutralization of 66 accounts for the formation of the dihydrobenzofuran derivatives. As to the phenoxenium ion (65), it may exist in the singlet 65s or the triplet 65t state.

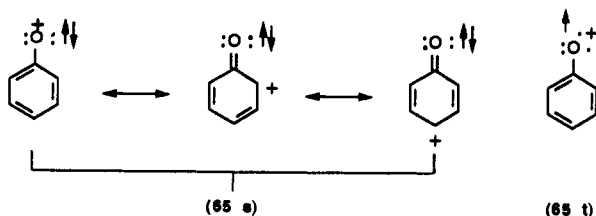

In the singlet state 65s, most of the charge is located at the *ortho* and *para* ring positions, whereas in the triplet state 65t the charge is mostly placed at the oxygen center. Thus, 65t predominantly attacks the H of the

cyclic ether yielding eventually phenol, while 65s attacks the cyclic ether according to Scheme 27.

On these grounds, formation of the benzodioxane derivatives in oxirane and propene oxide is attributed to the addition of a singlet phenoxenium ion 65s to the oxygen atom of a second ether molecule yielding the oxonium intermediates 67 and 68, which, depending on their structure and the substrate concentration, may either isomerize to 69 (only for 67) or start a polymerization sequence.

In oxetane, no benzocyclic products are recovered, most of the activity residing in aromatic ring of phenol. This is indicative of a preferred fragmentation of the excited primary oxonium ion 70 with formation of O-protonated phenol and a C_3H_4 moiety (eq 36).

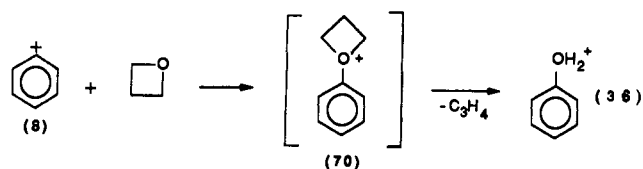

Tackling the problem of the reactivity of phenylium ion toward cyclic ethers by the decay technique has opened up a way for investigating the intimate nature and the intrinsic reactivity properties of phenoxenium ions and to compare them with those observed in solution. Given the considerable interest in the chemistry of phenoxenium ions, particularly in connection with phenol oxidation in general,¹⁵² and biosynthetic-type oxidative coupling reactions in particular,¹⁵³ it is worth mentioning the nuclear-decay procedures of Scheme 26 for generating singlet phenoxenium ions in the gas phase.

The reaction of nucleogenic phenylium ions with liquid acetic acid yields predominantly phenyl acetate (79%), together with minor amounts of phenol (9%), phenylacetic acid (6%), and unknown products (6%).¹⁵⁴

Formation of tritiated phenyl acetate is attributed to attack of 8 on both the carbonylic and the hydroxylic oxygens of acetic acid, followed by fast proton transfer from the ensuing oxonium ion to a second molecule of acetic acid. In competition with proton transfer, the oxonium intermediate arising from attack of 8 at the OH of acetic acid undergoes unimolecular fragmentation with formation of phenol and CH_3CO^+ . Given the presence of extensive hydrogen bonding in liquid acetic acid, the results of this investigation appears in clear contradiction with the conclusions of the same authors about the reactivity of nucleogenic CT_3^+ toward acetic acid (part iv of section IV.A.2.a).^{107a}

vi. Phenylium Ions with Bidentate Arenes. The study of the aromatic reactivity of nucleogenic phenylium ions 8 has been further extended to bidentate aromatic substrates, such as $\text{C}_6\text{H}_5\text{Y}$ ($\text{Y} = \text{F}, \text{Cl}, \text{CH}_3\text{O}$), where both a π system and an n center are present. *p*-T-Phenylium ions, generated from the β decay of 1,4- T_2 -benzene, were allowed to react with $\text{C}_6\text{H}_5\text{Y}$ in competition with benzene, either in the gaseous and in the condensed phase.^{138a,b} High yields (49–95%) of the corresponding biphenyl derivatives are obtained, together with minor amounts of the labeled starting $\text{C}_6\text{H}_5\text{Y}$ (5–22%) in the liquid decay samples. In anisole mixtures, tritiated diphenyl ether is formed as well

Scheme 27

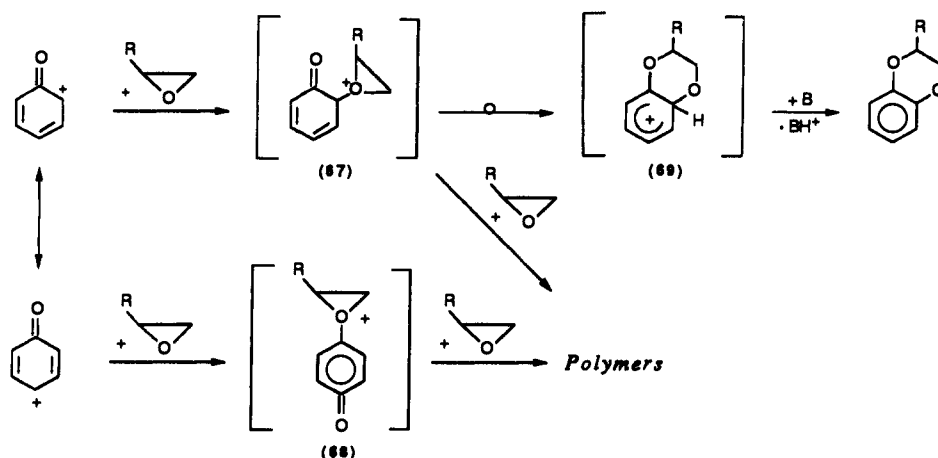

Scheme 28

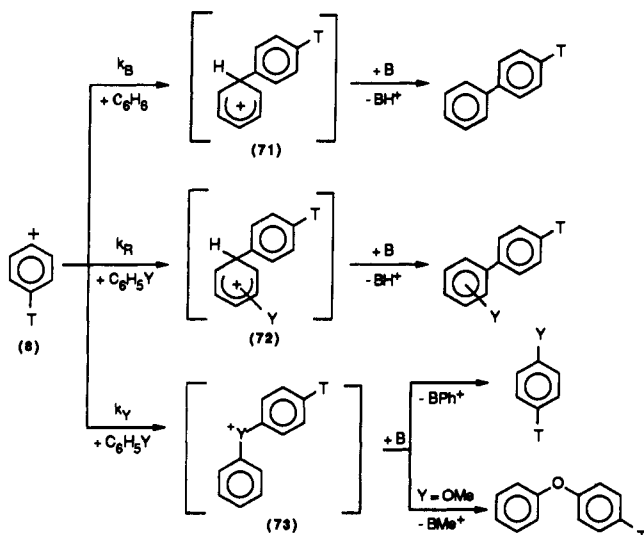

Table 14. Rate Constant Ratios of Attack of Phenylum Ion on C_6H_5Y ($Y = F, Cl, \text{ and } OCH_3$)/ C_6H_6 Mixtures in the Liquid ($T = 25^\circ C$) and Gaseous Phase ($T = 100^\circ C$)

phase	Y	kinetic parameters		
		$(k_R + k_Y)/k_B$	k_R/k_B	k_Y/k_R
liquid	F	0.7	0.5	0.3
liquid	Cl	1.6	0.7	1.4
liquid	OCH_3	6.6	2.5	1.7
gas	F	1.5	0.7	1.0
gas	Cl	1.7	0.3	5.8
		f_a	f_m	f_p
liquid	F	0.7	0.3	1.1
liquid	Cl	1.0	0.6	0.8
liquid	OCH_3	4.9	1.0	3.3

(45%). The product distribution is consistent with the reaction network of Scheme 28.

According to the reaction Scheme 28, kinetic significance can be attached to the relative distribution of products, provided that the rates of cross-disproportionation and phenyl-group transfer among the ionic intermediates 71–73 are low relative to neutralization. On these grounds the apparent rate constant ratios for the competing pathways of Scheme 28 are reported in Table 14, together with the partial rate factors for the attack of 8 to the π systems of substituted arenes. In the same table, the kinetic parameters relative to the same reactions carried out in the gas phase at $100^\circ C$,

at pressures ranging from *ca.* 10 to *ca.* 100 Torr, are summarized.

As for alkylbenzenes (part iv of this section), the data of Table 14 indicates that attack of 8 on C_6H_5Y/C_6H_6 is characterized by a low substrate discrimination, except perhaps for $Y = OCH_3$, in both gaseous and liquid phase. However, while the distribution of isomeric substituted biphenyls measured in liquid phase is consistent with the classical model of electrophilic aromatic substitution in condensed phase by a very reactive and rather unselective ionic electrophile, that measured in the gas phase is characterized by the predominant formation of the *meta* isomers [70–76% ($Y = F$); 80–100% ($Y = Cl$)]. This is consistent with the isomerization mechanism shown in eq 35, which is favored by the inefficient collisional quenching and the increased lifetime of the excited arenium intermediates 58 in the gas phase. In general, the same conclusions drawn for attack of 8 on gaseous alkylbenzenes are valid here for C_6H_5Y .

The k_R/k_B ratios and the partial rate factors concerning the attack of 8 on liquid arenes (Table 14) follow the typical pattern of classical electrophilic aromatic substitution by powerful electrophiles in condensed media. In fact, they indicate a distinct preference of 8 for the most activated aromatic ring ($F < Cl < H < OCH_3$), at its *ortho* and *para* positions. Furthermore, the formation of appreciable yields of the labeled C_6H_5Y under all conditions points to a direct attack of 8 at the substituent as well to an extent which increases with the relative nucleophilicity of the Y group ($F < Cl < OCH_3$), as shown by the relevant k_Y/k_R ratios.

vii. *Acylium Ions.* The decay technique has been employed to generate in the gas-phase acylium ions RCO^+ ($R = CT_3, C_6T_5$) and to investigate their intrinsic reactivity toward organic compounds.

Tritiated acetyl cations, CT_3CO^+ , were conveniently prepared via alkylation of carbon monoxide by nucleogenic CT_3^+ ions (eq 37).¹⁵⁵

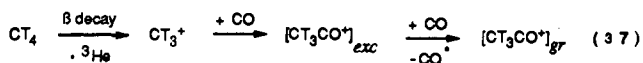

The excited acetyl cations from the strongly exothermic alkylation process (eq 37) ($-\Delta H^\circ = ca. 80 \text{ kcal mol}^{-1}$) undergo a large number of unreactive collisions with the molecules of CO present in excess in the gaseous mixture, before attacking the organic substrate. As a

Table 15. Products Yields in the Gas-Phase Reactions of Decay Formed CT_3CO^+ Ions

system composition (Torr)	products (activity, %) ^{a,b}
CO (720)	EtOAc (90.6)
EtOH (9.8)	MeOAc (5.2)
methane (0.19)	EtOH ^c (2.4)
	unknowns (2.0)
CO (720)	acetophenone ^d
benzene (3.0)	benzene (80.4)
methane (0.19)	toluene (8.2)
	MeOAc (5.6)
	unknowns (5.8)

^a Standard deviation of data *ca.* 10%. ^b The total activity recovered in the products accounts for 35% of the theoretical yield in the case of EtOH and for 15% in the case of C_6H_6 . ^c This yield is not significant owing to labile hydrogen atom exchange with GC columns. ^d Not detectable.

Table 16. Gas-Phase Reactions of Decay-Formed $PhCO^+$ Ions with EtOH and Benzene

system composition (Torr)	products (activity, %) ^a
$C_6H_4T_2$ (1.73 mCi)	phenyl ethyl ether (4.9)
CO (760 Torr)	ethyl benzoate (95.1)
EtOH (7 Torr)	
$C_6H_4T_2$ (2.47 mCi)	(benzophenone) ^b
CO (760 Torr)	biphenyl (96.9)
C_6H_6 (10 Torr)	benzoic acid (3.1)

^a Standard deviation of data *ca.* 10%. The total activity recovered in the products accounts for 35% of the theoretical yield in the case of EtOH and for 16% in the case of benzene. ^b Not detectable (<0.5%).

consequence, the reactivity of CT_3CO^+ measured in these systems refers to thermally equilibrated species.

The gas-phase reaction of CT_3CO^+ with ethanol and benzene has been investigated, and the relevant data are listed in Table 15.¹⁵⁵

In contrast with the efficient acetylation of ethanol, no tritiated acetophenone is recovered from the benzene systems. This result, confirmed by independent radiolytic¹⁵⁵ and mass spectrometric evidence,¹⁵⁶ is consistent with an endothermic gas-phase attack of acetyl cations on benzene, due to the very mild electrophilic character of the ionic reactant.

Similarly, benzyl cations were obtained from the reaction of nucleogenic phenylium ions with carbon monoxide (eq 38).¹⁵⁷

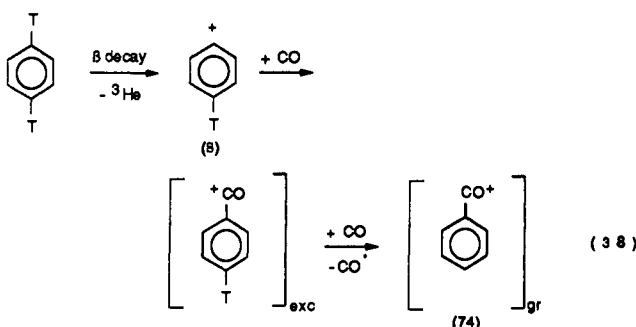

Their gas-phase reactivity toward ethanol and benzene has been investigated and compared to that of CT_3CO^+ . The relevant results are summarized in Table 16.

Likewise CT_3CO^+ , benzyl cations show a sharp discrimination between the n center of ethanol and the

Table 17. Gas-Phase Reactions of Decay-Formed Tritiated Benzoyl Cations with Activated Arenes

system composition	products (absolute yield, %) ^a
$C_6H_4T_{x-6}$ (1.17 mCi)	C_6Me_5COPh (<0.5)
CO (630 Torr)	
C_6Me_5H (5 Torr)	
$C_6H_4T_{x-6}$ (1.03 mCi)	PhOCOPh (59.4)
CO (630 Torr)	HOC ₆ H ₄ COPh (<0.5)
PhOH (5 Torr)	^b (8.5)
$C_6H_4T_{x-6}$ (1.40 mCi)	PhNHCOPh (41.4)
CO (630 Torr)	H ₂ NC ₆ H ₄ COPh (<0.5)
PhNH ₂ (4 Torr)	^b (12.4)
$C_6H_4T_{x-6}$ (1.10 mCi)	PhOCOPh (3.7)
CO (630 Torr)	CH ₃ OC ₆ H ₄ COPh (46.5 <i>para</i> ; 3.4 <i>ortho</i>)
PhOCH ₃ (11 Torr)	^b (11.3)

^a Absolute yields, *i.e.*, the ratio of the activity of the tritiated product to the maximum activity theoretically incorporable in the products. The remaining activity is mostly accounted for by low-boiling fragmentation products. Standard deviation of data, *ca.* 10%. ^b Ring and heteroatom phenylation products.

π system of benzene, underlined by the high yield of ethyl benzoate and by the absence of benzophenone among the products from the reaction with benzene.

The scarce reactivity of multitritiated benzoyl cation toward pure π systems has been further demonstrated using a strongly activated, pure π -type substrate, *i.e.* pentamethylbenzene,¹⁵⁸ which is known to be considerably more reactive than benzene toward acetylating agents in solution.¹⁵⁹ The absence of benzoylation products in the decay samples underlines the inefficiency of the gas-phase attack of benzoyl cations toward pentamethylbenzene, in spite of the considerable activation of its aromatic ring (Table 17).

The lack of reactivity of the gaseous benzoyl cation toward π -type nucleophilic centers, even when activated by powerful electron-releasing substituents, is confirmed by the observation that phenol and aniline undergo benzoylation exclusively at the heteroatom (Table 17).^{158,160} In the case of anisole, instead, appreciable ring benzoylation is observed, characterized by a remarkably high (up to 30:1) bias for the *para* position.¹⁶⁰

The results conform to a simple model, based on the assumption that the rate of attack on the n-type center of the aromatic substrate is much higher than of ring benzoylation (eq 39).

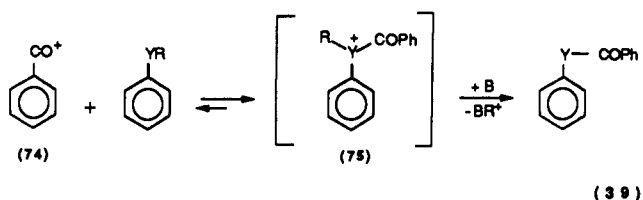

According to thermochemical calculations, the onium intermediate 75 lies in a shallow potential-energy well and, therefore, undergoes facile back-dissociation unless rapid neutralization by the base B (NMe₃, or the substrate itself) takes place.

Efficient neutralization by fast proton transfer can occur for phenol and aniline (R = H), whereas the adduct 75 from anisole (R = CH₃) obviously cannot readily evolve into neutral products owing to the required much slower CH₃⁺ removal by the base B. As a consequence,

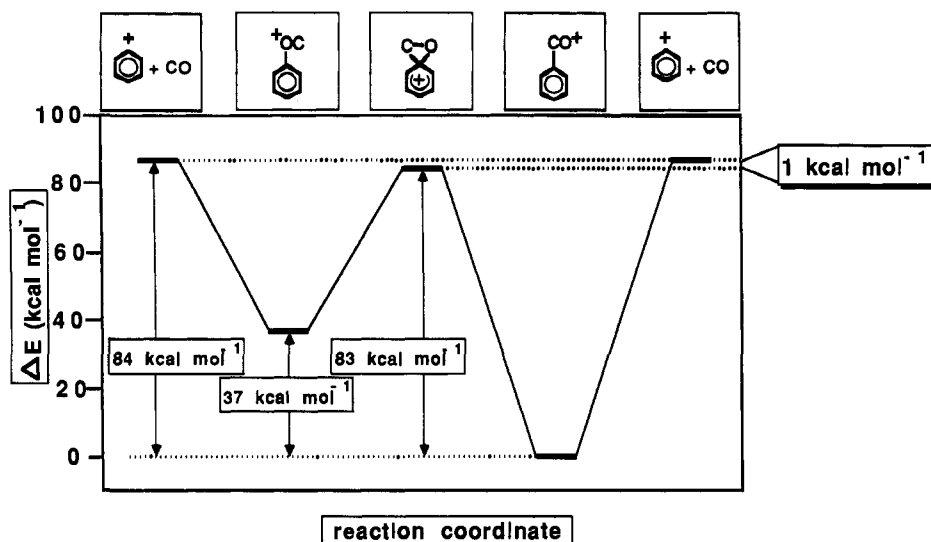
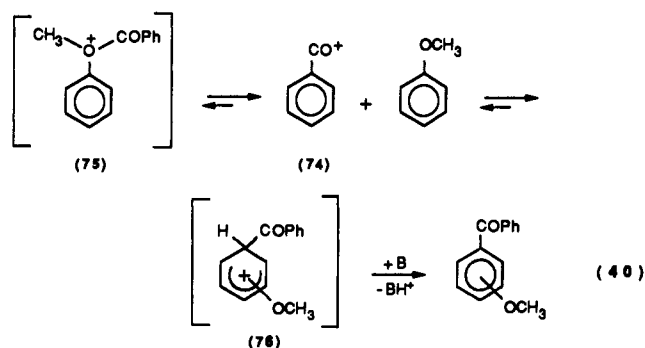

Figure 12. SCF STO-3G calculated relative energies of $C_7H_5O^+$ species.

back-dissociation of 75 predominates, allowing detection of the slower reaction channel, *i.e.* ring substitution (eq 40).



The isomeric benzoylated arenium ions 76 can in turn evolve into neutral derivatives, *i.e.* isomeric methoxybenzophenones, via fast deprotonation by the gaseous base B. The results of these studies characterize gaseous acetyl and benzoyl cations as mild, very selective electrophiles, which display a sharp kinetic bias for the *n*-type center of ambident substrates and, whenever ring substitution occurs, for the position *para* to the substituent.

The relative yields of phenylation *vs* acylation products in the decay systems indicate a sharp kinetic discrimination of the gaseous phenylium ion 8 for the aromatic substrates, measured by an apparent $k_{CO}/k_{C_6H_5YR}$ ratio of 0.12 (YR = OH), 0.13 (YR = OCH_3), and 0.04 (YR = NH_2) in systems at nearly atmospheric pressure. These apparent CO *vs* arenes discrimination of phenylium ion is due to an inherently slower addition of the ion to CO, as a result of a strong kinetic bias of 8 for the O atom of CO, yielding 77 as the primary adduct (eq 41).

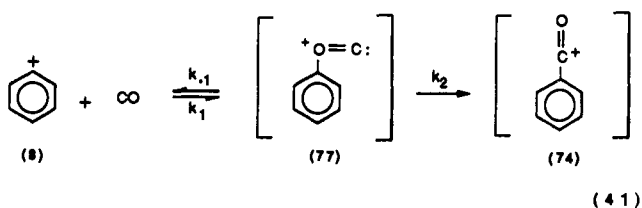

According to related theoretical estimates (Figure 12),¹⁶¹ isomerization of adduct 77 to the benzoyl cation 74 is allowed only to a very limited fraction of excited 77, with an internal energy excess sufficient to overcome the activation barrier for isomerization (k_2), but insufficient to undergo back-dissociation (k_{-1}). The narrow energy window between the back-dissociation and the isomerization barriers explains the inefficiency of the benzoylation channel relative to the phenylation one.

The study of the gas-phase reactivity of acylium ions, RCO^+ , has been extended to heteroarenes, *i.e.* pyrrole, *N*-methylpyrrole, furan, and thiophene, as well.¹⁶² Under all conditions acylation represents the major reaction pathway, leading to predominant α substitution in all systems (*e.g.* pyrrole >88%).

These results, discussed in the framework of the curve-crossing model,¹⁴⁷ suggest that gas-phase acylation of the selected heteroarenes proceeds via the two-step substitution mechanism shown in eq 42, involving a quasiresonant single electron transfer (SET) step followed by radical-radical ion recombination within the pair 78.

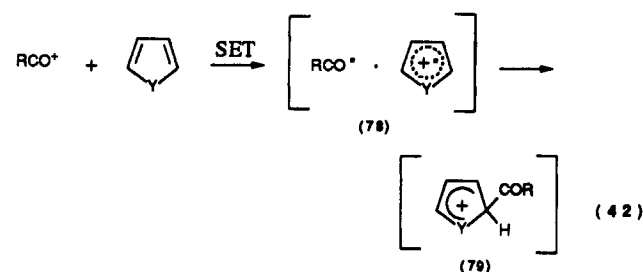

The pronounced inter- and intramolecular selectivity of benzoyl cation strikingly contrasts with the poor selectivity attributed to phenylvinyl cations (part ii of this section),^{127,128} showing the dramatic effect upon the intrinsic reactivity of unsaturated carbenium ions of the moieties (O *vs* CH_2) directly connected to the charged carbon.

B. Carbocations from the Tritonation of Hydrocarbons by $^3HeT^+$ Ions

The unusual properties of $^3HeT^+$, formed with a 95% yield from the decay of T_2 , have been exploited for the

Table 18. Labeled Products from the Interaction of HeT⁺ Ions with Alkanes

alkane	yields of products (%)						overall yield (%)
	CH ₃ T	C ₂ H ₅ T	C ₂ H ₃ T	C ₃ H ₇ T	<i>n</i> -C ₄ H ₉ T	<i>i</i> -C ₄ H ₉ T	
CH ₄	40	2	13				55
C ₂ H ₆	14	34					48
C ₃ H ₈	12.8	5.1		12.3			30.2
<i>n</i> -C ₄ H ₁₀	15.2	6.2	2.5	2.3	15.3		41.5
<i>i</i> -C ₄ H ₁₀	23.4	1.7	3.5	3.2		17.9	49.7

preparation of a number of carbonium and carbenium ions, and the study of their structural and reactivity features in both gaseous and liquid phase.

Helium tritide ion is a stable species,¹⁶³ characterized by a ΔH_f° value of *ca.* 320 kcal mol⁻¹ and a bond distance of 0.765 Å.^{110,164} Owing to the extreme weakness of its conjugate base, the helium atom having a proton affinity of only 40 kcal mol⁻¹, the ³HeT⁺ ion is an exceedingly powerful acid, which exothermically tritonates all organic compounds, including very weak bases like methane. The technique used in these experiments involves the decay of a tracer activity of T₂ dissolved in a large excess of the substrate of interest, kept at a given temperature (and pressure for gaseous mixtures) for periods of up to several months, followed by analysis of tritiated products with experimental techniques analogous to those outlined in section III.C.

The ³HeT⁺ has been used as a triton donor to a variety of σ -, π -, and *n*-type nucleophiles under largely different experimental conditions. In the following parts of this section, a survey of structural, stereochemical, and reactivity features of the tritonated intermediates generated by this procedure is presented.

1. Carbocations from the Tritonation of Alkanes

The reactions of the ³HeT⁺ ion, formed from the decay of gaseous T₂, with methane, ethane, propane, *n*-butane, and isobutane were investigated at pressures 20–760 torr and room temperature, under conditions ensuring against interference from radiolytic processes.¹⁶⁵ The results are summarized in Table 18.

In CH₄, while the yield of CH₃T is insensitive to the presence of 2% of oxygen and propane, that of both tritiated ethane and ethylene is significantly altered by the presence of these additives. In fact, addition of 2% of propane to the gaseous mixture increases the yield of C₂H₅T from 2 to 32%, while it decreases that of C₂H₃T from 13 to 0%.

It was suggested that exothermic tritonation of CH₄ by ³HeT⁺ represents the first step in a series of reactions leading to the formation of the tritiated products (eq 43).



The methonium ions 80 are sufficiently excited to fragment into methyl ions and hydrogen (path of a Scheme 29) unless they are stabilized by collisions with inactive methane (path b of Scheme 29).

While stabilized CH₄T⁺ undergoes a thermoneutral proton transfer to CH₄ forming CH₃T (eq 44), the CH₃⁺ (*H* = H, T) ion from path a of Scheme 29 reacts with methane yielding tritiated ethyl cations, which are

Scheme 29

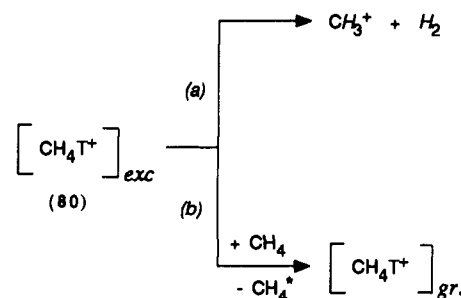

Scheme 30

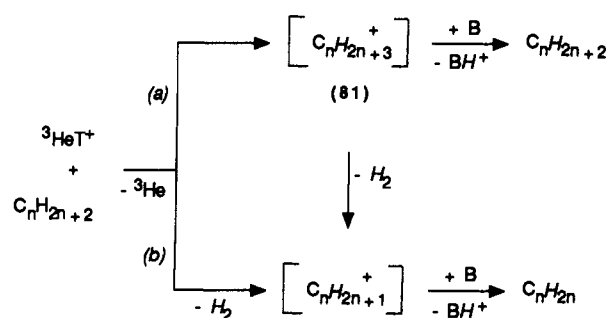

completely unreactive toward CH₄ (eq 14), as discussed in part i of section IV.2.a.

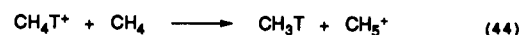

As shown there, the C₂H₅⁺ ions yield efficiently tritiated ethane in the presence of even low concentrations (2%) of propane (eq 16). The formation of tritiated ethylene, observed in neat CH₄, is ascribed to the exothermic proton transfer from the long-lived C₂H₅⁺ to an acceptor, *e.g.* H₂O, contained in the system as an impurity at an extremely low concentration.

The results from the decay of T₂ in CH₄ at atmospheric pressure are in general agreement with those of low-pressure mass spectrometric¹⁶⁶ and superacid solution chemistry studies on comparable systems.¹⁶⁷ In particular, the thermoneutral proton transfer (eq 44), which has been observed in both mass spectrometry¹⁶⁶ at 0.1 Torr and in "magic acid" (HSO₃F·SbF₅) solution of methane,¹⁶⁷ seems to represent a quite general channel of the methonium ion reactivity.

The gas-phase triton transfer to C₂–C₄ alkanes by ³HeT⁺ differs in several significant aspects from the tritonation of methane. A major feature of the results from these systems, summarized in Table 18, is represented by the comparatively low yields of the tritiated organic products (30–50%). Toward C₂–C₄ alkanes, in fact, the ³HeT⁺ ion displays both Brønsted and Lewis acid properties via the hydride ion transfer reaction b of Scheme 30.

Table 19. Labeled Products from the Reaction of $^3\text{HeT}^+$ Ions with Cycloalkanes

cycloalkane	yields of products (%) ^a								initial T-cycloalkane
	CH_4	C_2H_4	C_3H_6	C_2H_6	C_3H_8	C_4H_8	C_5H_{10}	C_6H_{12}	
cyclopropane	23.0	12.1	6.7	3.7	2.2				19.2
cyclobutane	1.3	11.1	8.4	6.1		12.1 ^b			6.9
cyclopentane		4.1	3.4	2.6	4.6		4.5 ^c		11.1
cyclohexane		1.6	3.0	1.2	2.7		1.3 ^c	3.1 ^d	9.7
bicyclo[2.1.0]pentane	16.1	0.5	12.2				7.1 ^e		3.8
bicyclo[3.1.0]hexane	12.4		4.0				2.9 ^e	0.4 ^f	1.7
bicyclo[4.1.0]heptane	15.2	1.9	14.2			2.3 ^g	8.1 ^h		6.2

^a The remainder is essentially HT. ^b *trans*-Butene. ^c *trans*-2-Pentene. ^d *trans*-2-Hexene. ^e 2-Methyl-2-Butene (1.4%) + cyclopentene (5.7%). ^f 1-Methylcyclopentene. ^g *cis*-2-Butene. ^h 2-Methyl-2-Butene + *trans*-2-pentene.

Scheme 31

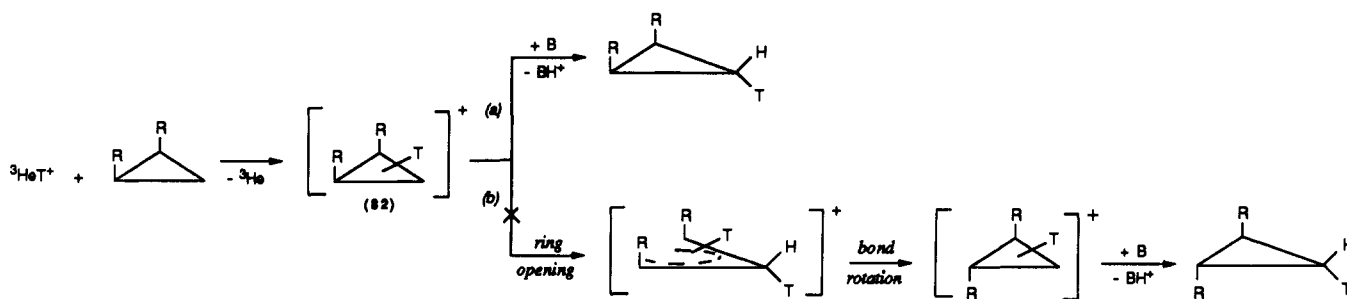

In C_2 – C_4 alkanes, the competition between paths a and b is biased in favor of the latter, thus determining a large yield of HT and relatively low yields of tritiated hydrocarbons. The other labeled products of Table 18 are formed from unimolecular fragmentation of the excited intermediates 81 with formation of tritiated neutral moieties (e.g. CH_3T from $\text{C}_3\text{H}_5\text{T}^+$ or $\text{C}_2\text{H}_5\text{T}$ from $\text{C}_4\text{H}_{10}\text{T}^+$), whose charged counterparts (e.g. $\text{C}_2\text{H}_4\text{T}^+$ from $\text{C}_3\text{H}_5\text{T}^+$ or $\text{C}_3\text{H}_6\text{T}^+$ from $\text{C}_4\text{H}_{10}\text{T}^+$) undergo hydride ion transfers from the parent hydrocarbons by processes analogous to eq 17. Even in these decay systems, the reaction pattern well conforms to the results of low-pressure mass spectrometric investigations on the protonation of C_2 – C_4 alkanes, where most of the protonating reactants were found to act in general as Lewis acids, as $^3\text{HeT}^+$ in path b of Scheme 30.^{85e,92,168}

There is no doubt, however, that the unique features of the decay technique proved most useful in problems concerning the structure of gaseous carbocations, which cannot be determined by other techniques. Thus, the isolation of tritiated cyclopropane, in yields significantly exceeding that of propylene (Table 19), from $^3\text{HeT}^+$ attack on cyclopropane at 760 Torr provides very good evidence for the occurrence of tritiated cyclopropane 82 (Scheme 31, $\text{R} = \text{H}$) as a gaseous ionic intermediate, with a lifetime exceeding 10^{-9} – 10^{-10} s.

The evidence for gaseous 82 becomes compelling in the case of 1,2-dimethylcyclopropane ($\text{R} = \text{CH}_3$), owing to the complete lack of *cis*–*trans* isomerization following the $^3\text{HeT}^+$ attack on the geometric isomers of 1,2-dimethylcyclopropane.¹⁶⁹

These results are of considerable interest both to mass spectrometry, in connection with the long-postulated intervention of 82 in the fragmentation of certain alkanes,¹⁷⁰ and to solution chemistry of carbocations, where protonated cyclopropanes play a prominent role.¹⁷¹

Processes similar to path a of Scheme 31 account for the formation of the tritiated starting compound in the tritiation of cyclobutane, cyclopentane, and cyclo-

hexane by $^3\text{HeT}^+$.¹⁷² The conclusion reached in this study can be summarized as follows: (i) In the $^3\text{HeT}^+$ tritiation of gaseous cycloalkanes, a fraction of their tritiated intermediates is stabilized by collision and retains a cyclic structure. (ii) The tritiated intermediates exhibit a tendency to rearrange to a linear structure (ring opening), the extent of isomerization being comparable for $n = 3, 5$, and 6 and greater for $n = 4$. (iii) The linear isomeric ions tend to transfer a proton to the cycloalkanes, rather than accepting a hydride ion from them. (iv) Among the possible olefins, only the thermodynamically most stable *trans*-2 isomers are formed.

The conclusions can be extended to the results of $^3\text{HeT}^+$ tritiation of bicycloalkanes, i.e. bicyclo[2.1.0]pentane, bicyclo[3.1.0]hexane, and bicyclo[4.1.0]heptane, obtained at 100–300 Torr and 90 °C (Table 19).¹⁷³ Here, the higher strain present in the bicyclic tritiated species than in the corresponding monocyclic ones leads to a higher tendency toward ring opening, as demonstrated by comparison of the yields of tritiated products retaining the original structure of their unlabeled precursors; cyclo- $\text{C}_5\text{H}_9\text{T}$ (11.1%) vs bicyclo- $\text{C}_5\text{H}_7\text{T}$ (3.8%); cyclo- $\text{C}_6\text{H}_{11}\text{T}$ (9.7%) vs bicyclo- $\text{C}_6\text{H}_9\text{T}$ (1.7%). The fragmentation of the bicyclic tritiated intermediates is also highly sensitive to specific structural factors. Thus, the major C_5 product from the gas-phase tritiation of bicyclo[2.1.0]pentane is represented by labeled cyclopentene (5.7%), whose formation involves the internal-bond cleavage (eq 45) of the cyclopropane ring according to a mechanism which finds a close analogy in the internal-bond cleavage of bicyclo[2.1.0]pentane promoted by acid attack in solution.¹⁷⁴

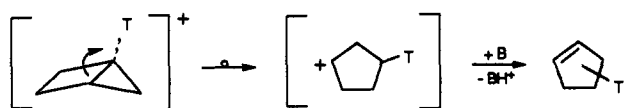

On the contrary, no labeled cyclohexene is isolated among the products from tritiation of bicyclo[3.1.0]hexane, and the external-bond cleavage (eq 46) of the cyclopropane ring leading to methylcyclopentene, a major reaction pathway in solution, does not represent a significant reaction channel in the gas phase, as shown by the low yield of tritiated 1-methylcyclopentene (0.4%) from $^3\text{HeT}^+$ tritiation of bicyclo[3.1.0]hexane (Table 19).

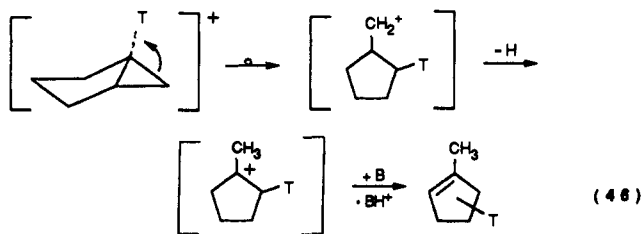

Use of chiral alkanes, such as *meso*- and *d,l*-1,2-dichloro-1,2-difluoroethane, has allowed the study of the stereochemical course of a gas-phase electrophilic attack at saturated carbon by the decay technique. Thus, $^3\text{HeT}^+$ ions were generated by decay of T_2 in the presence of gaseous *meso*-1,2-dichloro-1,2-difluoroethane at 3.6–147.0 Torr at room temperature.¹⁷⁵ The predominant retention of configuration in the labeled products [*erythro*/*threo* = 2.33 (3.6 Torr); 2.60 (44.0 Torr); 2.80 (147.0 Torr)] provides direct evidence for the frontside attack of the electrophile to the asymmetric center, as postulated by many authors on theoretical grounds (eq 47).¹⁷⁶

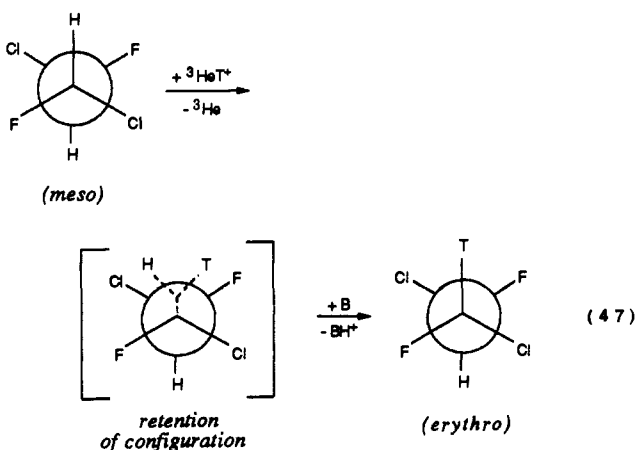

This finding is of particular interest since it refers to a model reaction occurring in the gas phase, free from the effect of solvation that considerably complicates similar processes in solution.¹⁷⁷ Furthermore, the process involves extremely simple reactants, perfectly defined from the structural and energetic standpoint, without the incursion of preliminary interactions, between them, *e.g.* bridging, frequently taking place in $\text{S}_{\text{E}}2$ processes in metal organic systems in solution.

2. Arenium Ions from the Tritonation of Aromatic Compounds

The application of the decay technique to the study of electrophilic aromatic substitution has been extended to a pure Brønsted acid, such as $^3\text{HeT}^+$, whose behavior, compared to that of pure Lewis acids, such as CT_3^+ (parts ii and v of section IV.2.a), $\text{C}_6\text{H}_5\text{CT}_2^+$ (part iii of

Table 20. Tritiated Products from the Interaction of $^3\text{HeT}^+$ Ions with Aromatic Compounds

aromatic compound	yields of products (%)		
	initial [T] compd	[T] benzene	other products
$\text{C}_6\text{H}_5\text{CH}_3$	60 ± 8	3.8 ± 0.5	[T] methane (about 8%)
$\text{C}_6\text{D}_5\text{CD}_3$	60 ± 8	3.6 ± 0.5	[T] methane (about 6%)
$\text{C}_6\text{D}_5\text{C}_4\text{H}_9$	65 ± 10	25 ± 4	[T] toluene (0.9 ± 0.1%), [T] ethylbenzene and [T] xylenes (3.6 ± 0.4%)
$\text{C}_6\text{H}_5\text{OCH}_3$	49 ± 10	2.0 ± 0.2	
$\text{C}_6\text{H}_5\text{F}$	67 ± 10	<0.2	
$\text{C}_6\text{H}_5\text{Cl}$	76 ± 10	3.7 ± 0.8	
$\text{C}_6\text{H}_5\text{Br}$	69 ± 10	8 ± 1	
$\text{C}_6\text{H}_5\text{CF}_3$	81 ± 10	2.9 ± 0.3	

section IV.2.a), C_2T_3^+ (part ii of section IV.2.b), and $\text{C}_6\text{H}_4\text{T}^+$ (parts iv and vi of section IV.2.b), provides the basis for a general model of electrophilic aromatic substitution in both the gaseous and the liquid phase. To this purpose, a tracer activity of T_2 was allowed to decay in the aromatic substrate of interest, either in the gas phase at pressures up to several hundred torr or in the liquid phase, for a period of several months.¹⁷⁸ Invariably, the major product recovered from the decay samples is the tritiated aromatic substrate itself, formed together with much minor amounts of labeled fragmentation products, as illustrated in Table 20.

A general outline of the mechanism suggested for tritideprotonation involves the primary formation of excited arenium ions 83 (Scheme 32), followed by their partial collisional stabilization and by the loss of a proton to some base B, including other substrate molecules contained in the system.

In the gas phase, the excited arenium ions 83 are efficiently stabilized by collision with the molecules of the aromatic substrate (M in path b of Scheme 32), if present at sufficiently high concentrations. A notable exception is represented by the *tert*-butylarenium ion 83 ($\text{Y} = t\text{-C}_4\text{H}_9$), whose facile decomposition into benzene and the stable *tert*-butyl cation (eq 48) gives high yields of tritiated benzene (Table 20) in close analogy with mass spectrometric,⁹² radiolytic,¹⁷⁹ and solution chemistry¹⁸⁰ observations on the extensive protodealkylation of *tert*-butylbenzene.

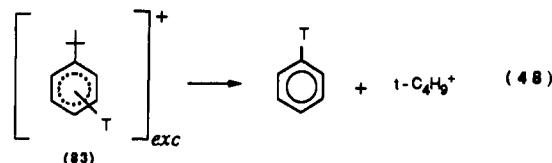

The excited arenium ions 83 that escape stabilization fragment according to the processes shown in Scheme 33, leading respectively, to the formation of the labeled benzene, HT, and TY.

Accordingly, when $\text{Y} = \text{CH}_3$, labeled benzene and methane represent the major fragmentation products recovered from gaseous decay samples. It was suggested that the original site of attack of $^3\text{HeT}^+$ determines the mode of fragmentation of the excited intermediate. Thus, the attack on the Y-substituted position of the ring leads to the formation of labeled benzene (path a of Scheme 33), the attack on the other ring positions may cause elimination of HT (path b of Scheme 33), and the attack on the substituent Y gives rise to the

Scheme 32

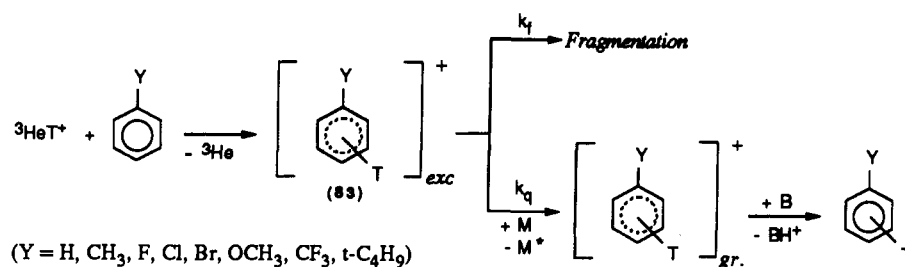

Scheme 33

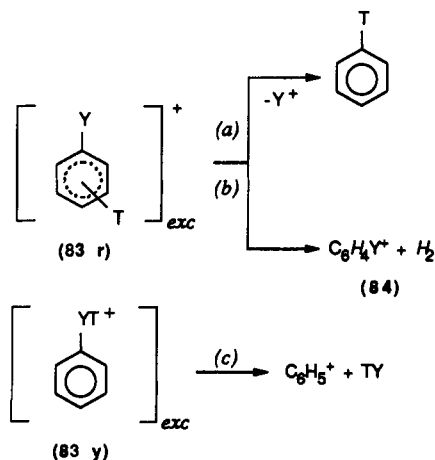
Table 21. Substrate Selectivity of the Gas-Phase Attack of ³HeT⁺ on Aromatics

substituent group (Y)	yields relative to benzene
CF ₃	0.8
H	1.0
F	1.2
CH ₃	1.5
Cl	1.6
Br	2.0
CN	2.2
OCH ₃	3.0

formation of TY (path c of Scheme 33). The latter two processes are identified as the major route for the activity loss in these systems, corresponding to the difference between the activity of the ³HeT⁺ reagent and the combined activity of the reaction products identified (Table 20). In the tritination of anisole, this difference is substantial (ca. 49%) and is due to the bimolecular fragmentation of 83Y (Y = OCH₃), induced by nucleophilic substitution on its CH₃ center by another molecule of anisole, yielding eventually C₆H₅-OT, whose mobile T atom is rapidly exchanged.

Valuable information upon the structure of the arenium intermediates 83 and the nature of the tritination process is obtained from the kinetic analysis of the competition experiments and the measurements of the intramolecular distribution of tritium in the final labeled products.

Competition experiments demonstrate that the ³HeT⁺ cation displays in the gas phase a low, but significant substrate selectivity (Table 21), which however reveals striking differences from the selectivity measured in solution, since all substrates, with the exception of (α,α,α-trifluoromethyl)benzene, react faster than benzene, irrespective of the nature of the substituent groups.

Scheme 34

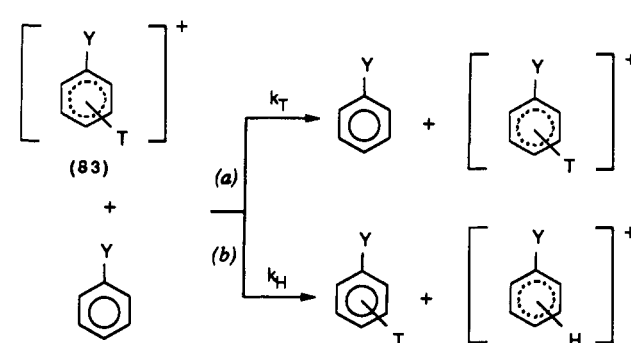

The analysis of the intramolecular distribution of tritium in the labeled aromatic substrates allows the evaluation of the site selectivity of ³HeT⁺, or at least its lower limit. Indeed, it is in principle possible that the T distribution in the final products does not match the selectivity of the ³HeT⁺ attack, if inter- or intramolecular T-atom shifts or selective HT loss take place in excited 83 prior to neutralization. This latter hypothesis is excluded on the grounds of specific experiments of ³HeT⁺ tritination of toluene and octadeuteriotoluene.^{178a} The observation of the same intramolecular distribution of T in both substrates [7 ± 1% (α); 52 ± 2% (ortho); 18 ± 1% (meta); 23% (para)] indicates that intramolecular T distribution is not significantly affected by the thermoneutral triton transfer a of Scheme 34, which could compete with the proton transfer b of Scheme 34.

The failure to observe a measurable change in the positional selectivity when the reaction is carried out with octadeuteriotoluene is taken as an evidence that either the loss of T⁺ from 83 is considerably slower than the loss of D⁺ (and *a fortiori* of H⁺), *i.e.* $k_H \gg k_T$, or the difference in the positional selectivity of ³HeT⁺ and 83 (in path a of Scheme 34) is not large enough to be detected.

On these grounds, it is suggested that the intramolecular T distribution in the labeled aromatic substrates is indeed representative of the site selectivity of ³HeT⁺. The results, illustrated in Figure 13, reflect the typical electrophilic character of the ³HeT⁺ attack, whose distinctive feature is the relatively pronounced positional selectivity, in contrast with the unusually low substrate selectivity.

The same reactivity pattern is obtained if the attack of ³HeT⁺ is carried out in liquid arenes.^{178b} The attack of ³HeT⁺ on liquid benzene, toluene, and their mixtures, leads to quantitative yields of the corresponding tritiated arenes, according to a reaction network analogous to that outlined for the gas phase. The higher (100%) yields of labeled arenes, and the lack of

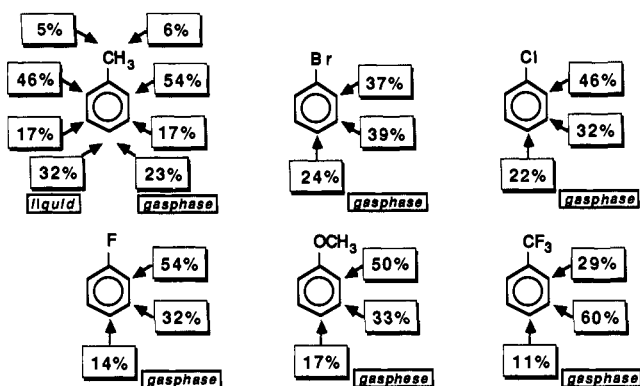

Figure 13. Positional selectivity of the ${}^3\text{HeT}^+$ ion toward substituted benzenes.

fragmentation products, reflect the higher efficiency of collisional stabilization in the liquid phase. Essentially, arenium ions **83** ($Y = \text{H}, \text{CH}_3$), excited by the large exothermicity of their formation processes [Scheme 32; $-\Delta H^\circ$ (kcal mol^{-1}) = *ca.* 100 ($Y = \text{H}$); *ca.* 110 ($Y = \text{CH}_3$)], readily undergo collisional quenching and neutralization prior to fragmentation ($k_q[\text{M}] \gg k_f$). Competition experiments fail to detect any substrate selectivity of ${}^3\text{HeT}^+$, whose attack on benzene and toluene appears entirely indiscriminate. On the contrary, the intramolecular distribution of T within the labeled toluene formed (Figure 13) indicates the appreciable positional selectivity of the ${}^3\text{HeT}^+$ in the liquid phase. If the extreme electrophilic character of the unsolvated reactant, and the indiscriminate nature of its attack on the different substrates are taken into account, the observation of the positional selectivity of ${}^3\text{HeT}^+$ in the liquid phase is of interest.

Indeed, any mechanism on which the individual positions of the aromatic ring compete for the electrophile in the rate-determining step seems to be ruled out, and the reactivity of ${}^3\text{HeT}^+$, as well as of other nucleogenic electrophiles, *i.e.* CT_3^+ , $\text{C}_6\text{H}_5\text{CT}_2^+$, C_2T_3^+ , and $\text{C}_6\text{H}_4\text{T}^+$, can be best explained by the early formation of some kind of electrostatically bonded "encounter complex" **85**, kinetically if not structurally analogous to the π complex advocated by Olah⁹⁹ and to the "encounter pair" postulated by Ridd,¹⁸¹ which subsequently evolves to the covalently bonded σ complex **86**, wherein the electronic effects of the substituent Y are fully developed (Scheme 35).

Whenever k_2 exceeds k_{-1} , as in the present cases, formation of the encounter complex **85** is rate determining, and the reaction proceeds essentially at the collision frequency (k_T/k_B *ca.* 1). In contrast with the lack of substrate selectivity, the reactant E^+ may still retain measurable positional selectivity, as a result of the different k_2 values for the formation of the isomeric σ complexes **86**.

Scheme 35

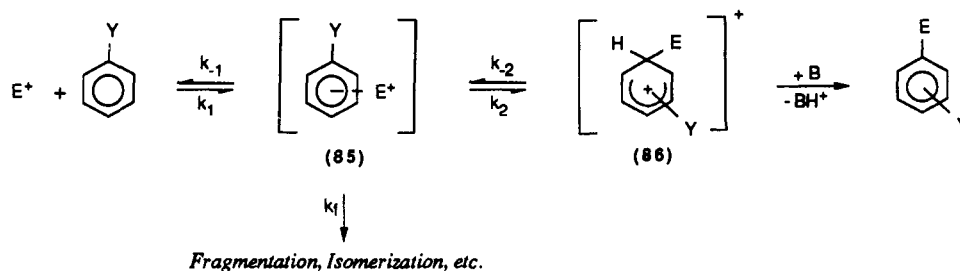

k (rel)	Structure	T distr.
3		45% 37% 18%
2		56% 40% 4%
1.5		62% 38%
0.7		18% 82%
1.0		

Figure 14. Substrate and positional selectivity of the ${}^3\text{HeT}^+$ ion toward gaseous five-membered heteroarenes.

When, instead, k_{-1} exceeds k_2 , formation of **85** is not rate determining, and the electrophile E^+ displays a remarkable substrate and positional selectivity.

In conclusion, the encounter complex **85** in reactions involving free, unsolvated ionic electrophiles plays the same kinetic role of the "early complex" in the same reactions involving solvated electrophiles in solution. While, here, the "early complex" is stabilized by viscosity factors, there the encounter complex is held together by electrostatic interactions.

The study of the reactivity of ${}^3\text{HeT}^+$ has been extended to heteroarenes, such as pyrrole, *N*-methylpyrrole, furan, and thiophene as well.¹⁸² The ability of the decay method to generate free, unsolvated ions in the gas phase, coupled with the recognition that ${}^3\text{HeT}^+$ ion is a reasonable approximation of the positive point charge considered in theoretical investigation of heteroaromatic reactivity, makes the decay approach best suited to provide experimental results against which theoretical predictions can correctly be compared.¹⁸³

The tritiated heteroaromatic substrate is the major product from all systems investigated, and its intramolecular T distribution is reported in Figure 14. The substrate and positional selectivity displayed by ${}^3\text{HeT}^+$ toward heteroarenes well conforms to the reaction model of Scheme 35, with $k_2 \gg k_{-1}$, and to theoretical predictions based upon molecular electrostatic potential established in the encounter pair.^{94f,g}

Clearly, no correspondence exists between these gas-phase results and those of more conventional reactions in solution, where predominant α substitution is

Scheme 36

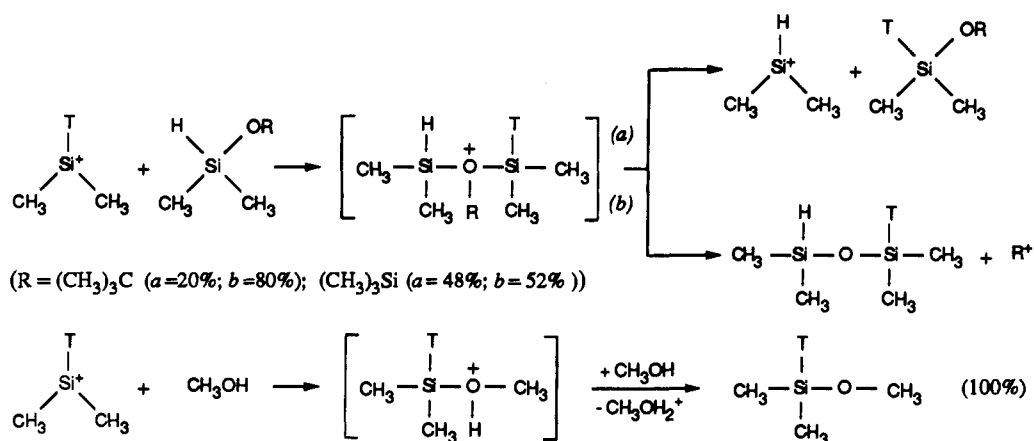

invariably observed.⁹³ The discrepancy points to the influence of the reaction medium (solvation, ion pairing, catalyst, *etc.*) as the main factor responsible for the "classical" reactivity and selectivity features of heteroaromatics toward electrophilic substitution in solution.

C. Sila-, Oxa-, Azacarbenium Ions from the Decay of Multitritiated Precursors

As previously noted, a fundamental feature of the decay technique is the possibility to obtain positively charged species having a defined structure, isomeric composition, internal energy, and initial location of the positive charge. These properties are determined by the structure of the tritiated precursor and by the position of the tritium atoms in it.

Use of covalent tritides of certain elements as the labeled precursors makes it possible to generate the corresponding closed-shell cations of these elements, which are analogous of carbenium ions, and to investigate their structural, electronic, and reactivity properties.

1. Silicenium Ions

The proximity of silicon to carbon in the same group of the periodic table has led to many comparative studies of the chemistry of the two elements, and although there are similarities between them there are also many differences. For example, at variance with carbon, silicon, in its chemical behavior, tends to expand its coordination, *e.g.* from sp^3 to sp^3d or sp^3d^2 state. Furthermore, differently from carbon, silicon hardly forms multiple p_π - p_π bonds, whereas it is capable to establish p_π - d_π interactions.

Concerning the positively charged species, silicon is less electronegative than carbon (1.8 *vs* 2.5 in Pauling scale), and thus, formation of $R_3\text{Si}^+$ ions by heterolytic cleavage of $\text{Si}^{\delta+}-\text{X}^{\delta-}$ ($\text{X} = \text{C}$, halogen, *etc.*) bonds should be easier than the corresponding formation of analogous $R_3\text{C}^+$ species. This is indeed the case in the gas phase where $R_3\text{Si}^+$ ions are abundant in mass spectra and the appearance potentials of $R_3\text{Si}^+$ are lower than for $R_3\text{C}^+$ ions. The question of formation of $R_3\text{Si}^+$ species in solution has, however, been a subject of much debate and remains probably the most controversial subject in organosilicon chemistry.¹⁸⁴

The nuclear-decay approach is the method of choice for investigating the nature and the reactivity of

silicenium ions $R_3\text{Si}^+$ in the gas phase over a wide range of pressures and also in the liquid and solid phase. Accordingly, dimethylsilicenium ions were obtained from decay of $(\text{CH}_3)_2\text{SiT}_2$ and their reactivity toward *tert*-butoxydimethylsilane, pentamethyldisiloxane, and methanol investigated.¹⁸⁵ The corresponding reactions are reported in Scheme 36.

The behavior of nucleogenic $(\text{CH}_3)_2\text{SiT}^+$ is not far from that of the related, but much stronger, electrophiles CT_3^+ and C_6T_5^+ under comparable experimental conditions (see part iv of section IV.2.a and part v of section IV.2.b). This example shows how the decay method represents the most convenient or, perhaps, the only approach to the silicenium ion chemistry not only in dense gases, but also in solution, owing to its unique property to generate the same free, unsolvated nucleogenic ions under all experimental conditions.

2. Oxenium Ions

As mentioned in part v of section IV.2.b, considerable interest is attached to the chemistry of oxenium ions RO^+ , particularly in connection with oxidation processes in biosynthesis.^{152,153}

The reactivity of the simplest oxenium ion, *i.e.* HO^+ , toward benzene has been investigated in the liquid at room temperature.¹⁸⁶ The attack of OT^+ ions, generated from the decay of T_2O , on benzene leads to formation of phenol (57%), labeled benzene (25%), and biphenyl (7%), together with small amounts of unidentified tritiated products (11%).

The reaction pattern is consistent with a distinct electrophilic character for OT^+ , which is isoelectronic to CT_3^+ . As for this latter nucleogenic ion, the attack on benzene leads to the formation of both the expected substituted product, *i.e.* phenol, and to labeled benzene, via intramolecular isotope exchange between the T atom of OT^+ and a ring hydrogen (Scheme 37). The high yield (25%) of tritiated benzene found experimentally indicates the high efficiency of isotope exchange (k_2) in the encounter complex 87 in comparison with the rate of its back-dissociation (k_{-1}). The occurrence of isotopic exchange is testified also by the fact that most of the activity of phenol is found in the aromatic ring and not in the hydroxy group.

Conversion of the intermediate 88 to 89, followed by elimination of the formed H_2O , accounts for the formation of labeled biphenyl.

Scheme 37

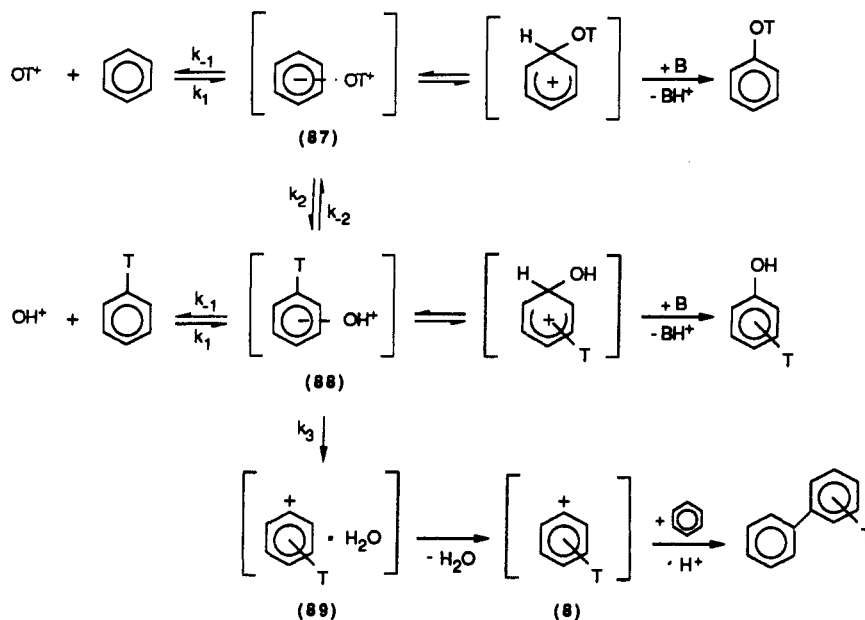

Scheme 38

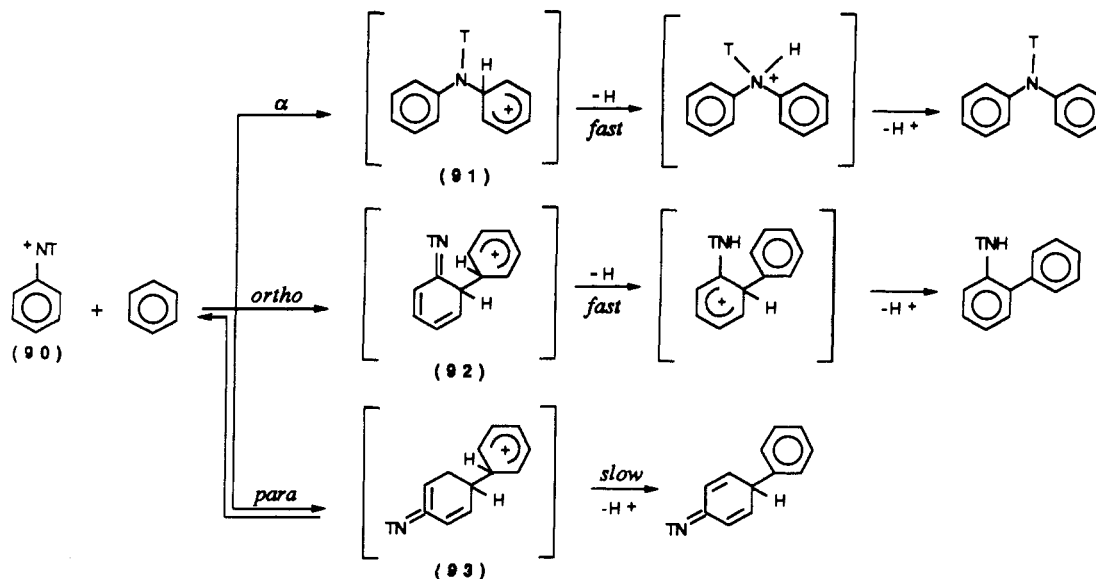

The proposed reaction pattern does not indicate whether the OT^+ has the singlet or triplet configuration. Since, as pointed out previously, the reactivity of hydroxyl cations in the two electronic states is expected to be very different, it is conceivable, although still not proved, that the labeled products isolated in these decay systems arise from the mixtures of OT^+ ions of different electronic multiplicity.

3. Nitrenium Ions

The question of the electronic multiplicity of oxenium ions applies to the isoelectronic nitrenium ions, *i.e.* RNH^+ , as well. The intermediacy of nitrenium ions in reactions, such as rearrangements of *N*-hydroxylamines,¹⁸⁷ decomposition of azides,¹⁸⁸ *etc.*, is still matter of lively debate. Therefore, the generation of nitrenium transients in the free, unsolvated state and the achievement of the best conditions to evaluate their intrinsic reactivity toward various substrates are undoubtedly of interest for answering the above mechanistic questions.

A first step in this direction makes use of the decay technique, employed to generate free phenylnitrenium ions ($R = C_6H_5$) from β decay of $C_6H_5NT_2$.¹⁸⁹ The so-formed phenylnitrenium ion was allowed to react with liquid benzene¹⁹⁰ and toluene¹⁹¹ at room temperature. In the case of benzene,¹⁹⁰ the major products are diphenylamine (55%), *o*-phenylaniline (40%), and *p*-phenylaniline (5%).

At first glance, the $\alpha > ortho > para$ substitution rate, derived from the labeled product composition, does not match the $para > ortho > \alpha$ one, expected for singlet phenylnitrenium ion **90s** on the grounds of theoretical calculations.¹⁹² A possible rationale is illustrated in Scheme 38.

Despite the $para > ortho > \alpha$ electron density in **90s**, the small yields of the labeled *para* isomer is accounted for by the lack of a rapid C-to-N proton transfer in **93**, besides occurring readily for proximity reasons in **91** and **92**, making neutralization of **93** slower and, thus, its back-dissociation more probable. However, this is only one of the possible explanations. In fact, the role

of the triplet phenylnitrenium ion $90t$ in the decay systems is never considered as well as the incursion of interfering radiolytic processes. In fact, for this specific system, the radiometric procedures, normally used in the analysis of the decay products, are unsuitable owing to the high mobility of the tritium atoms on the nitrogen of the labeled products which induces their rapid exchange and, thus, their loss during chromatographic procedures. Therefore, the authors were forced to analyze the stable, exchanged products, whose detectable accumulation in the decay systems required long storage periods (several months) and very high specific activities of the multitritiated precursor. As warned in Section III.B, these conditions cannot ensure against radiolytic artifacts and the isolated products may well arise from both nucleogenic and radiolytic intermediates.

The suspicion about the possible radiolytic nature of the reaction products is reinforced by the results of the reaction when the substrate is toluene.¹⁹¹ Here, *p*-tolylphenylamine was exclusively formed (100%), a result hardly consistent with the charge distribution within its hypothetical precursor $90s$, suggesting again that its formation can be due to undesired radiolytic processes.

Albeit the interpretation of these not very orthodox decay experiments is questionable, nevertheless they gave the way to orthodox application of the decay technique, to obtain otherwise inaccessible information on the nature and the reactivity of free, unsolvated nitrenium ions.

V. Concluding Remarks

This survey demonstrates that a correct use of the T decay technique can provide conclusive answers to structural, reactivity, and mechanistic questions concerning virtually all carbocations. Two unique features concur with this ability, namely the actual isolation of structurally diagnostic derivatives of the nucleogenic ions and the possibility to generate exactly the same carbocation under all experimental conditions, from dilute gas state to dense gases, to liquid and to solid phase.

Assessment of the structure of a charged intermediate from that of its neutral derivatives is common practice in solution. The study of the reaction mechanisms involving nucleogenic carbocations benefits as well from its high structural resolution, which allows, for instance, determination of the isomeric composition of the products and, consequently, the evaluation of crucial kinetic parameters, such as partial rate factors and free-energy correlations, as well as the stereochemical course of the reactive events, leading to their ionic precursors.

Furthermore, the decay techniques allows characterization of the same free carbocation in all systems of interest. On one side, under conditions ensuring effective collisional stabilization of excited ions, it becomes feasible to study ionic processes under conditions of kinetic, rather than thermodynamic, control of the products. On the other side, the approach shows considerable promise as a means of establishing kinetic and mechanistic correlations between gas-phase and condensed-phase ion chemistry.

VI. Acknowledgments

The generous financial support by the Ministero della Ricerca Scientifica e Tecnologica (MURST) and the Consiglio Nazionale delle Ricerche (Progetto Finalizzato: "Chimica Fine II") is gratefully acknowledged. The author is particularly indebted to his colleagues and co-workers, whose names are listed in the references, for their dedication and their practical and conceptual contributions to the present work and to Mrs. L. Fabrizi for her invaluable help in the preparation of the manuscript. A special acknowledgement is due to F. Cacace for his continuous support and encouragement.

VII. References

- (1) (a) Olah, G. A.; Prakash, G. K. S.; Sommer, J. *Superacids*; Wiley: New York, 1985. (b) Olah, G. A., Schleyer, P. v. R., Eds. *Carbonium Ions*, Wiley: New York, Vol. 1, 1968; Vol. 2, 1970; Vol. 3, 1972; Vol. 4, 1973; Vol. 5, 1976.
- (2) Farrar, J. M., Saunders, W. H., Jr., Eds. *Techniques for the Study of Ion-Molecule Reactions*; Wiley: New York, 1988.
- (3) Speranza, M. *Int. J. Mass Spectrom. Ion Processes* **1992**, 118/119, 395.
- (4) Cacace, F. *Proceedings of the Conference on the Methods for Preparing and Storing Marked Molecules, Bruxelles 1963*; Sarchis, J., Ed.; Euratom: Bruxelles, 1964; p 719.
- (5) Cacace, F. *Adv. Phys. Org. Chem.* **1970**, 8, 79.
- (6) Cacace, F.; Giacomello, P. *J. Chem. Soc., Perkin Trans. 2* **1978**, 652.
- (7) (a) Cacace, F. *Interactions between Ions and Molecules*; Ausloos, P., Ed.; Plenum Press: New York, 1975; p 527. (b) Cacace, F. *Hot Atom Chemistry Status Report*; Rowland, F. S., Ed.; IAEA: Vienna, 1975; p 229. (c) Akulov, G. P. *Usp. Khim.* **1976**, 45, 1970. (d) Cacace, F. *Science* **1990**, 250, 392.
- (8) Cacace, F.; Speranza, M. In *Techniques for the Study of Ion/Molecule Reactions*; Farrar, J. M., Saunders, W. H., Jr., Eds.; Wiley: New York, 1988; Chapter VI, and references therein.
- (9) Wexler, S. In *Actions Chimiques et Biologiques des Radiations*; Haissinsky, M., Ed.; Masson: Paris, 1965; Vol. 8, p 107.
- (10) Hsiung, D.; Gordus, A. A. *Chemical Effects of Nuclear Transformations*; IAEA: Vienna, 1965; Vol. II, p 461.
- (11) Steinwedell, H.; Jensen, J. H. Z. *Naturforsch.* **1947**, 2a, 125.
- (12) Michels, H. H. *J. Chem. Phys.* **1966**, 44, 3834.
- (13) Koch, W.; Frenkling, G.; Gauss, J.; Cremer, D.; Collins, J. R. *J. Am. Chem. Soc.* **1987**, 109, 5917.
- (14) Migdal, A. *J. Phys. (USSR)* **1941**, 4, 449.
- (15) (a) Burdon, J.; Davies, D. W.; Del Conde, G. *J. Chem. Soc., Perkin Trans. 2* **1976**, 1193. (b) William, J. E., Jr.; Buss, V.; Allen, L. C.; Schleyer, P. v. R.; Lathan, W. A.; Hehre, W. J.; Pople, J. A. *J. Am. Chem. Soc.* **1971**, 93, 6867.
- (16) (a) Hopkins, A. C.; Yates, K.; Csizmadia, I. G. *J. Chem. Phys.* **1971**, 55, 3835. (b) Sustmann, R.; Williams, J. E., Jr.; Dewar, M. J. S.; Allen, L. C.; Schleyer, P. v. R. *J. Am. Chem. Soc.* **1969**, 91, 5350.
- (17) (a) Schleyer, P. v. R.; Kos, A. J.; Ragavachari, K. *J. Chem. Soc., Chem. Commun.* **1983**, 1296. (b) Dill, J. D.; Schleyer, P. v. R.; Binkley, J. S.; Seeger, R.; Pople, J. A.; Haselbach, E. *J. Am. Chem. Soc.* **1976**, 98, 5428.
- (18) Wexler, S. *J. Chem. Phys.* **1962**, 36, 1992.
- (19) (a) Carlson, T. A. *Phys. Rev.* **1963**, 130, 2361. (b) Wexler, S. *Proceedings of the Symposium on the Chemical Effects of Nuclear Transformations, Prague, 1960*; IAEA: Vienna, 1961; Vol. 4, p 115, and references therein.
- (20) Okuno, K.; Hiraga, M.; Yoshihara, K.; Shiokawa, T. *Mass Spectrosc.* **1976**, 24, 245.
- (21) Pobo, L. G.; Wexler, S.; Caronna, S. *Radiochim. Acta* **1973**, 19, 5.
- (22) (a) Snell, A. H.; Pleasonton, F.; Leming, H. E. *J. Inorg. Nucl. Chem.* **1957**, 5, 112. (b) Wexler, S. *J. Inorg. Nucl. Chem.* **1959**, 10, 8.
- (23) Snell, A. H.; Pleasonton, F. *J. Phys. Chem.* **1958**, 62, 1377.
- (24) Wexler, S.; Hess, D. C. *J. Phys. Chem.* **1958**, 62, 1382.
- (25) Wexler, S.; Anderson, G. R.; Singer, L. A. *J. Chem. Phys.* **1960**, 32, 417.
- (26) Carlson, T. A. *J. Chem. Phys.* **1960**, 32, 1234.
- (27) Nishizawa, K.; Narisada, K.; Teramatsu, H.; Iwami, H.; Shinagawa, M. *Mass Spectrosc.* **1973**, 21, 199.
- (28) Wilzbach, K. E. *J. Am. Chem. Soc.* **1957**, 79, 1013.
- (29) Cacace, F. *Treatise on Heavy Ion Science*; Bromley, D. A., Ed.; Plenum: New York, 1985; Vol. 6, p 63.
- (30) See, for instance: (a) Nefedov, V. D.; Sinotova, E. N.; Akulov, G. P.; Korsakov, M. V. *Zh. Org. Khim.* **1970**, 6, 1214. (b) Nefedov, V. D.; Sinotova, E. N.; Shishkunov, V. A. *Zh. Org. Khim.* **1976**, 12, 1491.

- (31) See, for instance: (a) Nefedov, V. D.; Sinotova, E. N.; Arkhipov, Yu. M.; Gomzina, N. A. *Radiokhimiya* 1983, 25, 557. (b) Nefedov, V. D.; Sinotova, E. N.; Akulov, G. P. *Radiokhimiya* 1968, 10, 609.
- (32) Cacace, F.; Ciranni, G.; Schüller, M. *J. Am. Chem. Soc.* 1975, 97, 4747.
- (33) Speranza, M.; Angelini, G.; Sparapani, C. *J. Labeled Compd. Radiopharm.* 1982, 19, 39.
- (34) (a) Korsakov, M. V.; Bystrova, M. O.; Mironyuk, T. A.; Sinotova, E. N.; Ivin, B. A.; Nefedov, V. D.; Likhachev, A. Ya. *Biochimie* 1989, 71, 633. (b) Korsakov, M. V.; Bystrova, M. O.; Mironyuk, T. A.; Kapustin, V. K.; Leonov, V. V.; Likhachev, A. Ya.; Sinotova, E. N.; Nefedov, V. D.; Ivin, B. A. *Zh. Org. Khim.* 1987, 23, 422.
- (35) Cacace, F.; Stöcklin, G. *Curr. Top. Radiat. Res. Q.* 1977, 12, 103.
- (36) (a) Nefedov, V. D.; Toropova, M. A.; Shchepina, N. E.; Avrorin, V. V.; Zhuravlev, V. E.; Trofimova, N. I. *Radiokhimiya* 1989, 31, 69. (b) Nefedov, V. D.; Toropova, M. A.; Shchepina, N. E.; Avrorin, V. V.; Shchepin, V. V. *Radiokhimiya* 1989, 31, 72. (c) Nefedov, V. D.; Toropova, M. A.; Shchepina, N. E.; Avrorin, V. V.; Zhuravlev, V. E.; Shchepin, V. V.; Trofimova, N. I. *Radiokhimiya* 1988, 30, 576. (d) Nefedov, V. D.; Toropova, M. A.; Shchepina, N. E.; Avrorin, V. V.; Shchepina, V. A.; Zhuravlev, V. E. *Radiokhimiya* 1987, 29, 237. (e) Shchepina, N. E.; Zhuravlev, V. E.; Shchepin, V. V.; Nefedov, V. D.; Toropova, M. A. *Sint. Medody Osn. Elementoorg. Soedin.* 1982, 75. (f) Shchepina, N. E.; Shchepin, V. V.; Zhuravlev, V. E.; Nefedov, V. D.; Toropova, M. A.; Avrorin, V. V. *Khim. Org. Soedin. Azota* 1981, 106. (g) Nefedov, V. D.; Toropova, M. A.; Shchepina, N. E.; Avrorin, V. V.; Zhuravlev, V. E. *Radiokhimiya* 1982, 24, 394. (h) Shchepina, N. E.; Nefedov, V. D.; Toropova, M. A. *Sint. Osn. Magnii Tsinkorg. Soedin.* 1980, 116. (i) Nefedov, V. D.; Toropova, M. A.; Avrorin, V. V.; Shchepina, N. E.; Vasil'ev, V. K. *Radiokhimiya* 1976, 18, 302. (j) Nefedov, V. D.; Toropova, M. A.; Avrorin, V. V.; Shchepina, N. E.; Vasil'ev, V. K. *Radiokhimiya* 1976, 18, 305.
- (37) (a) Nefedov, V. D.; Akulov, G. P.; Avrorin, V. V.; Bobrov, S. A.; Radiokhimiya 1979, 21, 914. (b) Akulov, G. P.; Geller, N. M.; Kropachev, V. A.; Nefedov, V. D.; Sinotova, E. N.; Skorokhodov, S. S.; Stepanov, V. V.; Toropova, M. A. *Vysokomol. Soedin., Ser. B* 1979, 21, 243. (c) Akulov, G. P.; Geller, N. M.; Kropachev, V. A.; Nefedov, V. D.; Sinotova, E. N.; Skorokhodov, S. S.; Stepanov, V. V.; Toropova, M. A. *Makromol. Chem.* 1978, 179, 2775. (d) Akulov, G. P.; Avrorin, V. V. *Khim. Vys. Energ.* 1981, 15, 173.
- (38) (a) Cacace, F.; Ciranni, G.; Guarino, A. *J. Am. Chem. Soc.* 1966, 88, 2903. (b) Ciranni, G.; Guarino, A. *J. Labelled Compd.* 1966, 2, 198. (c) Lemmon, R. M.; Muzzetti, R. T.; Reynolds, F. L.; Calvin, M. *J. Am. Chem. Soc.* 1956, 78, 6414. (d) Cacace, F.; Schüller, M. *J. Labelled Compd.* 1975, 15, 703. (e) Sinotova, E. N.; Korsakov, M. V.; Shishkunov, B. A. *Radiokhimiya* 1980, 22, 466. (f) Leonov, V. V.; Sinotova, E. N.; Korsakov, M. V. *Radiokhimiya* 1974, 16, 564.
- (39) Aliprandi, B.; Cacace, F.; Guarino, A. *J. Chem. Soc. (B)* 1967, 519.
- (40) Cacace, F.; Caroselli, M.; Guarino, A. *J. Am. Chem. Soc.* 1967, 89, 4584.
- (41) Nefedov, V. D.; Sinotova, E. N.; Arkhipov, Yu. M.; Kalinin, E. O. *Radiokhimiya* 1983, 25, 561.
- (42) Cacace, F.; Speranza, M. *J. Am. Chem. Soc.* 1979, 101, 1587.
- (43) Babernics, L.; Cacace, F. *J. Chem. Soc. (B)* 1971, 2313.
- (44) Attinà, M.; Cacace, F.; Cipollini, R.; Speranza, M. *J. Am. Chem. Soc.* 1985, 107, 4824.
- (45) Cacace, F.; Speranza, M.; Wolf, A. P.; Ehrenkaufner, R. *J. Labelled Compd. Radiopharm.* 1982, 19, 905.
- (46) Angelini, G.; Speranza, M.; Segre, A. L.; Altman, L. J. *J. Org. Chem.* 1980, 45, 3291.
- (47) Fornarini, S.; Speranza, M. *Tetrahedron Lett.* 1984, 25, 869.
- (48) Nefedov, V. D.; Sinotova, E. N.; Kuzhelev, L. P.; Lebedev, V. P. *Radiokhimiya* 1986, 28, 144.
- (49) Angelini, G.; Hanack, M.; Vermehren, J.; Speranza, M. *J. Am. Chem. Soc.* 1988, 110, 1298.
- (50) (a) Hvistendahl, G.; Williams, D. H. *J. Chem. Soc., Perkin Trans. 2* 1975, 881. (b) Bowen, R. D.; Williams, D. H. *J. Chem. Soc., Perkin Trans. 2* 1976, 1479.
- (51) Fornarini, S.; Speranza, M. *J. Phys. Chem.* 1987, 91, 2154.
- (52) Cipollini, R.; Schüller, M. *J. Labelled Compd. Radiopharm.* 1978, 15, 703.
- (53) Cacace, F.; Cipollini, R.; Giacomello, P. *J. Phys. Chem.* 1982, 86, 2062.
- (54) Nefedov, V. D.; Sinotova, E. N.; Arkhipov, Yu. M.; Gomzina, N. A. *Radiokhimiya* 1983, 25, 557.
- (55) Nefedov, V. D.; Sinotova, E. N.; Arkhipov, Yu. M. *Vestn. Leningrad. Univ., Fiz. Khim.* 1983, 109.
- (56) Saunders, M.; Hagen, E. L.; Rosenfeld, J. *J. Am. Chem. Soc.* 1968, 90, 6882.
- (57) Sinotova, E. N.; Nefedov, V. D.; Skorokhodov, S. S.; Arkhipov, Yu. M. *Radiokhimiya* 1987, 29, 69.
- (58) Olah, G. A.; Reddy, V. P.; Prakash, G. K. S. *Chem. Rev.* 1992, 92, 69.
- (59) (a) McKee, M. L. *J. Phys. Chem.* 1986, 90, 4908. (b) Koch, W.; Liu, B.; De Fries, D. J. *J. Am. Chem. Soc.* 1988, 110, 7325. (c) Saunders, M.; Laidig, K. E.; Wiberg, K. B.; Schleyer, P. v. R. *J. Am. Chem. Soc.* 1988, 110, 7652.
- (60) (a) Hehre, W. J.; Hiberty, P. C. *J. Am. Chem. Soc.* 1972, 94, 5917. (b) Hehre, W. J.; Hiberty, P. C. *J. Am. Chem. Soc.* 1974, 96, 302.
- (61) Levi, B. A.; Blurock, E. S.; Hehre, W. J. *J. Am. Chem. Soc.* 1979, 101, 5537.
- (62) (a) Olah, G. A.; Lukas, J. *J. Am. Chem. Soc.* 1968, 90, 933. (b) Olah, G. A.; White, A. M. *J. Am. Chem. Soc.* 1969, 91, 5801.
- (63) Wesdemiotis, C.; Wolfschutz, R.; Schwarz, H. *Tetrahedron* 1979, 36, 275.
- (64) Attinà, M.; Cacace, F.; Di Marzio, A. *J. Am. Chem. Soc.* 1989, 111, 6004.
- (65) (a) Waters, W. A. *J. Chem. Soc.* 1942, 266. (b) Ambroz, H. B.; Kemp, J. T. *Chem. Soc. Rev.* 1979, 8, 353.
- (66) (a) Speranza, M. *Tetrahedron Lett.* 1980, 21, 1983. (b) Angelini, G.; Fornarini, S.; Speranza, M. *J. Am. Chem. Soc.* 1982, 104, 4773.
- (67) Dill, J. D.; Schleyer, P. v. R.; Binkley, J. S.; Seeger, R.; Pople, J. A.; Haselbach, E. *J. Am. Chem. Soc.* 1976, 98, 5428.
- (68) Dewar, M. J. S.; Reynolds, C. H. *J. Am. Chem. Soc.* 1982, 104, 3244.
- (69) Speranza, M.; Keheyhan, Y.; Angelini, G. *J. Am. Chem. Soc.* 1983, 105, 6377.
- (70) Schleyer, P. v. R.; Kos, A. J.; Ragavachari, K. *J. Chem. Soc., Chem. Commun.* 1983, 1296.
- (71) (a) Rinehart, K. L.; Bochholz, A. C.; Van Lear, G. E.; Cantrill, H. L. *J. Am. Chem. Soc.* 1968, 90, 2983. (b) Meyerson, S.; Hart, H.; Leitch, L. C. *J. Am. Chem. Soc.* 1968, 90, 3419. (c) Yeo, A. N. H.; Williams, D. H. *J. Chem. Soc., Chem. Commun.* 1970, 886. (d) Howe, I.; McLafferty, F. W. *J. Am. Chem. Soc.* 1971, 93, 99. (e) Bursley, J. T.; Bursley, M. M.; Kingston, D. G. I. *Chem. Rev.* 1973, 73, 91. (f) Siegel, A. *J. Am. Chem. Soc.* 1974, 96, 1251. (g) Tajima, S.; Tsuchiya, T. *Org. Mass Spectrom.* 1974, 9, 265. (h) Köppel, C.; Dymerski, P. P.; Bockoff, F. M.; McLafferty, F. W. *Adv. Mass Spectrom.* 1978, 7, 295.
- (72) Cacace, F.; Ciranni, G.; Sparapani, C.; Speranza, M. *J. Am. Chem. Soc.* 1984, 106, 8046.
- (73) Leung, H. W.; Ichikawa, H.; Li, Y. H.; Harrison, A. G. *J. Am. Chem. Soc.* 1978, 100, 2479.
- (74) Cone, C.; Dewar, M. J. S.; Landman, D. *J. Am. Chem. Soc.* 1977, 99, 372.
- (75) (a) Rylander, P. N.; Meyerson, S.; Grubb, H. M. *J. Am. Chem. Soc.* 1957, 79, 824. (b) Rylander, P. N.; Meyerson, S. *J. Chem. Phys.* 1957, 27, 901.
- (76) Sen Sharma, D. K.; Kebarle, P. *Can. J. Chem.* 1981, 59, 1592.
- (77) Cacace, F.; Ciranni, G.; Sparapani, C.; Speranza, M. *Radiochim. Acta* 1984, 35, 195.
- (78) Stang, P. J.; Rappoport, Z.; Hanack, M.; Subramanian, L. R. *Vinyl Cations*; Academic Press: New York, 1979.
- (79) Koch, E. W.; Siehl, H. U.; Hanack, M. *Tetrahedron Lett.* 1985, 26, 1493 and references therein.
- (80) (a) Burgers, P. C.; Holmes, J. L.; Mommers, A. A.; Szulejko, J. E. *J. Am. Chem. Soc.* 1984, 106, 521. (b) Huang, S. J.; Di Battista, F.; Picker, D.; Wilson, G. *J. Org. Chem.* 1975, 40, 124.
- (81) (a) Helwig, R.; Hanack, M. *Chem. Ber.* 1985, 118, 1008. (b) Hanack, M.; Vermehren, J.; Helwig, R.; Glaser, R. *Studies in Organic Chemistry Vol. 31, Physical Organic Chemistry*, Kobayashi, M., Ed.; Elsevier: Amsterdam, 1987.
- (82) Glaser, R. *J. Am. Chem. Soc.* 1987, 109, 4237.
- (83) (a) Ono, Y.; Ng, C. Y. *J. Chem. Phys.* 1981, 74, 6985. (b) Ragavachari, K.; Whiteside, R. A.; Pople, J. A.; Schleyer, P. v. R. *J. Am. Chem. Soc.* 1981, 103, 5649.
- (84) (a) Ikuta, S.; Okuno, K.; Yoshihara, K.; Shiokawa, T. *Radiochem. Radioanal. Lett.* 1975, 23, 213. (b) Okuno, K.; Yoshihara, K.; Shiokawa, T. *Radiochim. Acta* 1978, 25, 21. (c) Ikuta, S.; Iwata, S.; Imamura, M. *J. Chem. Phys.* 1977, 66, 4671.
- (85) (a) Lampe, F. W.; Field, F. H. *Tetrahedron* 1959, 7, 189. (b) Derwish, G. A. W.; Galli, A.; Giardini, A.; Volpi, G. G. *J. Chem. Phys.* 1964, 40, 5. (c) Field, F. H.; Munson, M. S. B. *J. Am. Chem. Soc.* 1965, 87, 3288. (d) Munson, M. S. B.; Field, F. H. *J. Am. Chem. Soc.* 1965, 87, 3297. (e) Haynes, R. M.; Kebarle, P. *J. Chem. Phys.* 1966, 45, 3899.
- (86) (a) Ausloos, P.; Lias, S. G. *J. Chem. Phys.* 1963, 38, 2207. (b) Ausloos, P.; Gordon, R., Jr. *J. Chem. Phys.* 1964, 41, 1278.
- (87) (a) Nefedov, V. D.; Kharitonov, N. P.; Sinotova, E. N.; Kochina, T. A.; Korsakov, M. V. *Zh. Obshch. Khim.* 1975, 45, 483. (b) Kochina, T. A.; Nefedov, V. D.; Sinotova, E. N.; Gomzina, N. A.; Kalinin, E. O. *Zh. Obshch. Khim.* 1989, 59, 1576.
- (88) Munson, M. S. B.; Field, F. H. *J. Am. Chem. Soc.* 1965, 87, 3294.
- (89) Nefedov, V. D.; Sinotova, E. N.; Akulov, G. P.; Korsakov, M. V. *Radiokhimiya* 1973, 15, 286.
- (90) Cacace, F.; Giacomello, P. *J. Am. Chem. Soc.* 1977, 99, 5477.
- (91) Giacomello, P.; Schüller, M. *Radiochim. Acta* 1977, 24, 111.
- (92) Munson, M. S. B.; Field, F. H. *J. Am. Chem. Soc.* 1967, 89, 1047.
- (93) (a) Katritzky, A. R.; Lagowski, J. M. *The Principles of Heterocyclic Chemistry*; Academic Press: New York, 1968. (b) Jones, R. A. *Adv. Heterocycl. Chem.* 1970, 11, 383.
- (94) (a) Hermann, R. B. *Int. J. Quantum Chem.* 1968, 2, 165. (b) Preston, H. J. T.; Kaufmann, J. J. *Int. J. Quantum Chem. Symp.* 1973, 7, 207. (c) Kaufmann, J. J.; Preston, H. J. T.; Kerman, E.; Cusach, L. C. *Int. J. Quantum Chem. Symp.* 1973, 7, 249. (d) Kao, J.; Hinde, A. L.; Ratom, L. *Nouv. J. Chim.* 1979, 3, 473. (e) Cordell, F. R.; Boggs, J. E. *J. Mol. Struct.* 1981, 85, 163. (f) Politzer, P.; Weinstein, H. *Tetrahedron* 1975, 31, 915. (g) Chou, D.; Weinstein, H. *Tetrahedron* 1978, 34, 275.
- (95) Speranza, M. *Adv. Heterocycl. Chem.* 1986, 40, 25.

- (96) Angelini, G.; Sparapani, C.; Speranza, M. *J. Am. Chem. Soc.* **1990**, *112*, 3060.
- (97) (a) Margonelli, A.; Speranza, M. *J. Chem. Soc., Perkin Trans. 2* **1983**, 1491. (b) Laguzzi, G.; Speranza, M. *J. Chem. Soc., Perkin Trans. 2* **1987**, 857.
- (98) Klopman, G. *J. Am. Chem. Soc.* **1968**, *90*, 223 and references therein.
- (99) Olah, G. A. *Acc. Chem. Res.* **1971**, *4*, 240.
- (100) De Haan, F. P.; Delker, G. L.; Covey, W. D.; Ahn, J.; Anisman, M. S.; Brehm, E. C.; Chang, J.; Chicic, R. M.; Cowan, R. L.; Ferrara, D. M.; Fong, C. H.; Harper, J. D.; Irani, C. D.; Kim, J. K.; Meinhold, R. W.; Miller, K. D.; Roberts, M. P.; Stoler, E. M.; Suh, Y. J.; Tang, M.; Williams, E. J. *J. Am. Chem. Soc.* **1984**, *106*, 7038.
- (101) Giacomello, P.; Angelini, G.; Sparapani, C.; Speranza, M. *J. Phys. Org. Chem.* **1989**, *2*, 467.
- (102) Nefedov, V. D.; Sinotova, E. N.; Bermudez, R. K. *Radiokhimiya* **1983**, *25*, 72.
- (103) Nefedov, V. D.; Sinotova, E. N.; Akulov, G. P.; Syreishchikov, V. A. *Radiokhimiya* **1968**, *10*, 600.
- (104) (a) Nefedov, V. D.; Sinotova, E. N.; Akulov, G. P.; Sass, V. P. *Radiokhimiya* **1968**, *10*, 761. (b) Zharov, V. T.; Nefedov, V. D.; Sinotova, E. N.; Korsakov, M. V.; Antonova, V. V. *Zh. Org. Khim.* **1978**, *14*, 35.
- (105) (a) Nefedov, V. D.; Sinotova, E. N.; Akulov, G. P.; Korsakov, M. V. *Zh. Org. Khim.* **1974**, *10*, 1586. (b) Nefedov, V. D.; Sinotova, E. N.; Akulov, G. P.; Korsakov, M. V. *Zh. Org. Khim.* **1973**, *9*, 629. (c) Nefedov, V. D.; Kochina, T. A.; Sinotova, E. N.; Kharitonov, N. P. *Zh. Obshch. Khim.* **1982**, *52*, 1599.
- (106) Nefedov, V. D.; Sinotova, E. N.; Bermudez, R. K. *Zh. Org. Khim.* **1982**, *18*, 1878.
- (107) (a) Nefedov, V. D.; Sinotova, E. N.; Balakin, I. M.; Arkhipov, Yu. M. *Radiokhimiya* **1983**, *25*, 143. (b) Nefedov, V. D.; Sinotova, E. N.; Bermudez, R. K. *Zh. Org. Khim.* **1980**, *16*, 2281. (c) Nefedov, V. D.; Sinotova, E. N.; Bermudez, R. K.; Korsakov, M. V. *Zh. Org. Khim.* **1975**, *11*, 1392.
- (108) (a) Nefedov, V. D.; Sinotova, E. N.; Akulov, G. P. *Radiokhimiya* **1968**, *10*, 609. (b) Colosimo, M.; Bucci, R. *J. Phys. Chem.* **1980**, *84*, 3326.
- (109) Nefedov, V. D.; Sinotova, E. N.; Leonov, V. V.; Akulov, G. P.; Korsakov, M. V. *Zh. Org. Khim.* **1973**, *9*, 1073.
- (110) Smith, R. D.; Futrell, J. H. *Int. J. Mass Spectrom. Ion Phys.* **1977**, *24*, 173.
- (111) Colosimo, M.; Bucci, R. *J. Phys. Chem.* **1978**, *82*, 2061.
- (112) Nefedov, V. D.; Sinotova, E. N.; Leonov, V. V.; Akulov, G. P.; Korsakov, M. V. *Zh. Org. Khim.* **1973**, *9*, 1073.
- (113) (a) Giacomello, P. *J. Am. Chem. Soc.* **1979**, *101*, 4276. (b) Giacomello, P. *Radiochim. Acta* **1979**, *26*, 185.
- (114) Brown, H. C.; Neyens, A. J. *J. Am. Chem. Soc.* **1962**, *84*, 1955.
- (115) Nefedov, V. D.; Sinotova, E. N.; Akulov, T. P. *Metod. Iztop. Indikatorov. Nauch.-Issled. Prom. Proizvod.* **1971**, 346.
- (116) Angelini, G.; Sparapani, C.; Speranza, M. *Gazz. Chim. Ital.* **1986**, *116*, 479.
- (117) Hart, L. S.; Waddington, C. R. *J. Chem. Soc., Perkin Trans. 2* **1985**, 1607.
- (118) (a) Mc Laughlin, M. P.; Creedon, V. E.; Miller, B. *Tetrahedron Lett.* **1978**, 3537. (b) Miller, B.; McLaughlin, M. P.; Marheva, V. C. *J. Org. Chem.* **1982**, *47*, 710. (c) Laali, K. *J. Org. Chem.* **1985**, *50*, 3638.
- (119) Kollmar, H.; Smith, H. O. *Angew. Chem., Int. Ed. Engl.* **1972**, *11*, 635.
- (120) (a) Modena, G.; Tonellato, U. *Adv. Phys. Org. Chem.* **1971**, *9*, 185. (b) Lodder, A. E.; Buck, H. M.; Oosterhoff, L. J. *Rec. Trav. Chim. Pays-Bas* **1970**, *89*, 1229. (c) Hogeveen, H.; Roobeek, C. F. *Tetrahedron Lett.* **1971**, 3343. (d) Wagner, H. U.; Gompper, R. *Tetrahedron Lett.* **1971**, 4061, 4065.
- (121) Lucchini, V.; Modena, G. *J. Am. Chem. Soc.* **1990**, *112*, 6291.
- (122) (a) Lossing, F. P. *Can. J. Chem.* **1971**, *49*, 357. (b) Lossing, F. P. *Can. J. Chem.* **1972**, *50*, 3973. (c) Field, F. H.; Lampe, F. W. *J. Am. Chem. Soc.* **1958**, *80*, 5587. (d) Smith, R. D.; Futrell, J. H. *Int. J. Mass Spectrom. Ion Phys.* **1976**, *20*, 71.
- (123) (a) Adams, N. G.; Smith, D. *Chem. Phys. Lett.* **1977**, *47*, 383. (b) Buttrill, S. E., Jr.; Kim, J. K.; Huntress, W. T., Jr.; Le Breton, P.; Williamson, A. J. *Chem. Phys.* **1974**, *61*, 2122. (c) Kim, J. K.; Anicich, V. G.; Huntress, W. T., Jr. *J. Phys. Chem.* **1977**, *81*, 1798. (d) Fornarini, S.; Gabrielli, R.; Speranza, M. *Int. J. Mass Spectrom. Ion Processes* **1986**, *72*, 137. (e) Senzer, S. N.; Lim, K. P.; Lampe, F. W. *J. Phys. Chem.* **1984**, *88*, 5314.
- (124) Fornarini, S.; Speranza, M. *J. Phys. Chem.* **1987**, *91*, 2154.
- (125) Su, T.; Bowers, M. T. *Gas Phase Ion Chemistry*; Bowers, M. T., Ed.; Academic Press: New York, 1979; Vol. 1, p 83.
- (126) (a) Fornarini, S.; Speranza, M. *J. Am. Chem. Soc.* **1985**, *107*, 5358. (b) Fornarini, S.; Speranza, M. *J. Am. Chem. Soc.* **1989**, *111*, 7402.
- (127) Nefedov, V. D.; Sinotova, E. N.; Kuzhelev, L. P.; Lebedev, V. P. *Radiokhimiya* **1987**, *29*, 73.
- (128) Kuzhelev, L. P.; Lebedev, V. P.; Nefedov, V. D.; Sinotova, E. N. *Zh. Org. Khim.* **1988**, *24*, 2590.
- (129) Speranza, M.; Sefcik, M. D.; Henis, J. M. S.; Gaspar, P. P. *J. Am. Chem. Soc.* **1977**, *99*, 5583.
- (130) Angelini, G.; Sparapani, C.; Speranza, M. *Tetrahedron* **1984**, *40*, 4865.
- (131) Angelini, G.; Sparapani, C.; Speranza, M. *J. Chem. Soc., Perkin Trans. 2* **1988**, 1393.
- (132) Attinà, M.; Cacace, F.; Giacomello, P. *J. Am. Chem. Soc.* **1980**, *102*, 4768.
- (133) (a) Takamuku, S.; Iseda, K.; Sakurai, H. *J. Am. Chem. Soc.* **1971**, *93*, 2420. (b) Cacace, F.; Possagno, E. *J. Am. Chem. Soc.* **1973**, *95*, 3397. (c) Attinà, M.; Cacace, F.; Ciranni, G.; Giacomello, P. *J. Am. Chem. Soc.* **1977**, *99*, 2611.
- (134) Morton, T. H. *J. Am. Chem. Soc.* **1980**, *102*, 1596.
- (135) Fornarini, S.; Speranza, M. *J. Chem. Soc., Chem. Commun.* **1985**, 1692.
- (136) Colosimo, M.; Speranza, M.; Cacace, F.; Ciranni, G. *Tetrahedron* **1984**, *40*, 4873.
- (137) Fornarini, S.; Speranza, M. *Gazz. Chim. Ital.* **1986**, *116*, 341.
- (138) (a) Angelini, G.; Keheyan, Y.; Speranza, M. *Helv. Chim. Acta* **1988**, *71*, 107. (b) Angelini, G.; Keheyan, Y.; Speranza, M. *Bull. Soc. Chim. Fr.* **1988**, *2*, 367. (c) Nefedov, V. D.; Sinotova, E. N.; Shishkunov, V. A. *Zh. Org. Khim.* **1976**, *12*, 1495. (d) Nefedov, V. D.; Sinotova, E. N.; Shishkunov, V. A. *Zh. Org. Khim.* **1976**, *12*, 1351. (e) Nefedov, V. D.; Sinotova, E. N.; Korsakov, M. V.; Shishkunov, V. A. *Zh. Org. Khim.* **1975**, *11*, 2350.
- (139) Filippi, A.; Occhiucci, G.; Speranza, M. *Can. J. Chem.* **1991**, *69*, 732.
- (140) (a) Eyley, J. R.; Campana, J. E. *Int. J. Mass Spectrom. Ion Processes* **1983/84**, *55*, 171. (b) Brill, F. W.; Eyley, J. R. *J. Phys. Chem.* **1981**, *85*, 1091.
- (141) (a) De La Mare, P. B. D.; Bolton, R. *Electrophilic Additions to Unsaturated Systems*; Elsevier: Amsterdam, 1982. (b) Mayr, M.; Striepe, W. *J. Org. Chem.* **1983**, *48*, 1159.
- (142) Nefedov, V. D.; Sinotova, E. N.; Korsakov, M. V.; Alekseev, E. G. *Radiokhimiya* **1973**, *15*, 635.
- (143) (a) Abramovitch, R. A.; Saha, J. G. *Can. J. Chem.* **1965**, *43*, 3269. (b) Abramovitch, R. A.; Gadallah, F. F. *J. Chem. Soc. (B)* **1968**, 497. (c) Eustathopoulos, H.; Court, J.; Bonnier, J. M. *J. Chem. Soc., Perkin Trans. 2* **1983**, 803.
- (144) Clark, D. T.; Murrell, J. N.; Tedder, J. M. *J. Chem. Soc.* **1963**, 1250.
- (145) Taft, R. W. *J. Am. Chem. Soc.* **1961**, *83*, 3350.
- (146) Speranza, M. *Pure Appl. Chem.* **1991**, *63*, 243 and references therein.
- (147) Bucci, R.; Grandinetti, F.; Filippi, A.; Laguzzi, G.; Occhiucci, G.; Speranza, M. *J. Am. Chem. Soc.* **1991**, *113*, 4550.
- (148) Keheyan, Y.; Speranza, M. *Helv. Chim. Acta* **1985**, *68*, 2381.
- (149) Fornarini, S.; Speranza, M. *J. Chem. Soc., Perkin Trans. 2* **1984**, 171.
- (150) Nefedov, V. D.; Sinotova, E. N.; Korsakov, M. V.; Alexeev, F. G. *Khim. Vys. Energ.* **1975**, *9*, 130.
- (151) Fornarini, S.; Speranza, M. *Can. J. Chem.* **1988**, *66*, 2506.
- (152) (a) McDonald, P. D.; Hamilton, G. A. *Oxidation in Organic Chemistry*; Trahanovsky, W. S., Ed.; Academic Press: New York, 1973. (b) Mihailovic, M. L. J.; Cekovic, Z. *The Chemistry of the Hydroxyl Group*; Patai, S., Ed.; Wiley-Interscience: New York, 1971.
- (153) (a) Barton, D. H. R. *Chem. Ber.* **1967**, *3*, 330. (b) Taylor, W. I.; Battersby, A. R. *Oxidative Coupling of Phenols*; Dekker: New York, 1967.
- (154) Nefedov, V. D.; Sinotova, E. N.; Balakin, I. M. *Zh. Org. Khim.* **1980**, *16*, 458.
- (155) Giacomello, P.; Speranza, M. *J. Am. Chem. Soc.* **1977**, *99*, 7918.
- (156) Chatfield, D. A.; Bursey, M. M. *J. Chem. Soc., Faraday Trans. 1* **1976**, *72*, 417.
- (157) Occhiucci, G.; Patacchiola, A.; Sparapani, C.; Speranza, M. *J. Chem. Soc., Chem. Commun.* **1982**, 1269.
- (158) Occhiucci, G.; Speranza, M.; Cacace, F. *J. Chem. Soc., Chem. Commun.* **1984**, 723.
- (159) Brown, H. C.; Bolto, B. A.; Jensen, F. R. *J. Org. Chem.* **1958**, *23*, 417.
- (160) Occhiucci, G.; Cacace, F.; Speranza, M. *J. Am. Chem. Soc.* **1986**, *108*, 872.
- (161) (a) Grandinetti, F.; Guarino, A.; Bernardi, F. Private communication. (b) Nobes, R. H.; Bouma, W. J.; Radom, L. *J. Am. Chem. Soc.* **1983**, *105*, 309.
- (162) Filippi, A.; Occhiucci, G.; Sparapani, C.; Speranza, M. *Can. J. Chem.* **1991**, *69*, 740.
- (163) Raitz von Frenzt, R.; Luchner, K.; Micklitz, H.; Wittver, V. *Phys. Lett.* **1974**, *47A*, 301.
- (164) (a) Green, T. A.; Michels, H. H.; Browne, J. C.; Madsen, M. M. *J. Chem. Phys.* **1974**, *61*, 5186. (b) Green, T. A.; Browne, J. C.; Michels, H. H.; Madsen, M. M. *J. Chem. Phys.* **1974**, *61*, 5189. (c) Green, T. A.; Michels, H. H.; Browne, J. C. *J. Chem. Phys.* **1976**, *64*, 3951. (d) Green, T. A.; Michels, H. H.; Browne, J. C. *J. Chem. Phys.* **1978**, *69*, 101.
- (165) (a) Cacace, F.; Cipollini, R.; Ciranni, G. *J. Am. Chem. Soc.* **1968**, *90*, 1122. (b) Cacace, F.; Caroselli, M.; Cipollini, R.; Ciranni, G. *J. Am. Chem. Soc.* **1968**, *90*, 2222. (c) Cacace, F.; Cipollini, R.; Ciranni, G. *Radiochem. Radioanal. Lett.* **1970**, *4*, 51.
- (166) (a) Munson, M. S. B.; Field, F. H.; Franklin, J. L. *J. Am. Chem. Soc.* **1963**, *85*, 3584. (b) Wexler, S. J. *J. Am. Chem. Soc.* **1963**, *85*, 272. (c) Aquilanti, V.; Volpi, G. G. *J. Chem. Phys.* **1966**, *44*, 2307.
- (167) Olah, G. A.; Schlosberg, R. H. *J. Am. Chem. Soc.* **1968**, *90*, 2726.

- (168) (a) Aquilanti, V.; Volpi, G. G. *J. Chem. Phys.* **1966**, *44*, 3574. (b) Field, F. H.; Munson, M. S. B. *J. Am. Chem. Soc.* **1967**, *89*, 4272. (c) Pettersson, E.; Lindholm, E. *Arkiv. Fysik.* **1963**, *24*, 49.
- (169) Cacace, F.; Guarino, A.; Speranza, M. *J. Am. Chem. Soc.* **1971**, *93*, 1088.
- (170) Rylander, P. N.; Meyerson, S. *J. Am. Chem. Soc.* **1956**, *78*, 5799.
- (171) Keating, J. T.; Skell, P. S. *Carbonium Ions*; Olah, G. A., Schleyer, P. v. R., Eds.; Wiley: New York, 1970; Vol. II, p 573.
- (172) Cacace, F.; Guarino, A.; Possagno, E. *J. Am. Chem. Soc.* **1969**, *91*, 3131.
- (173) Cacace, F.; Guarino, A.; Speranza, M. *J. Chem. Soc., Perkin Trans. 2* **1973**, 66.
- (174) La Ronde, R. T.; Forney, L. S. *J. Am. Chem. Soc.* **1963**, *85*, 3767.
- (175) Cacace, F.; Speranza, M. *J. Am. Chem. Soc.* **1972**, *94*, 4447.
- (176) (a) Reutov, O. A. *Rec. Chem. Progr.* **1961**, *22*, 1. (b) Olah, G. A.; Halpern, Y.; Shen, J.; Mo, Y. K. *J. Am. Chem. Soc.* **1971**, *93*, 1251.
- (177) Olah, G. A.; Klopman, G.; Schlosberg, R. H. *J. Am. Chem. Soc.* **1969**, *91*, 3261.
- (178) (a) Cacace, F.; Caronna, S. *J. Am. Chem. Soc.* **1967**, *89*, 6848. (b) Cacace, F.; Caronna, S. *J. Chem. Soc., Perkin Trans. 2* **1972**, 1604. (c) Cacace, F.; Perez, G. *J. Chem. Soc., Perkin Trans. 2* **1971**, 2086. (d) Cacace, F.; Cipollini, R.; Ciranni, G. *J. Chem. Soc., Perkin Trans. 2* **1971**, 2089.
- (179) Cacace, F.; Crestoni, M. E.; de Petris, G.; Fornarini, S.; Grandinetti, F. *Can. J. Chem.* **1988**, *66*, 3099.
- (180) (a) Brouwer, D. M. *Recl. Trav. Chim. Pay-Bas* **1968**, *87*, 210. (b) Olah, G. A.; Schlosberg, R. H.; Porter, R. D.; Mo, Y. K.; Kelly, D. P.; Mateescu, G. D. *J. Am. Chem. Soc.* **1972**, *94*, 2034.
- (181) Ridd, J. H. *Adv. Phys. Org. Chem.* **1978**, *16*, 1.
- (182) Speranza, M. *J. Chem. Soc., Chem. Commun.* **1981**, 1177.
- (183) Angelini, G.; Laguzzi, G.; Sparapani, C.; Speranza, M. *J. Am. Chem. Soc.* **1984**, *106*, 37.
- (184) (a) Nefedov, V. D.; Kochina, T. A.; Sinotova, E. N. *Uspekhi Khimii* **1986**, *55*, 794. (b) Lickiss, P. D. *J. Chem. Soc., Dalton Trans.* **2** **1992**, 1333.
- (185) Nefedov, V. D.; Kharitonov, N. P.; Sinotova, E. N.; Kochina, T. A.; Balakin, I. M. *Zh. Obshch. Khim.* **1980**, *50*, 2499.
- (186) Nefedov, V. D.; Akulov, G. P.; Volkovich, S. V. *Zh. Obshch. Khim.* **1976**, *46*, 906.
- (187) (a) Stieglitz, J.; Leech, P. N. *J. Am. Chem. Soc.* **1941**, *36*, 272. (b) Bamberger, E. *Liebigs Ann.* **1925**, *441*, 297. (c) Okamoto, T.; Shudo, K.; Ohta, T. *J. Am. Chem. Soc.* **1975**, *97*, 7184.
- (188) Hiroshi, T.; Katsuyuki, T. *J. Chem. Soc., Chem. Commun.* **1983**, 447.
- (189) Nefedov, V. D.; Toporova, M. A.; Simonova, T. P.; Avrorin, V. V.; Zhuravlev, V. E. *Radiokhimiya* **1989**, *31*, 137.
- (190) (a) Nefedov, V. D.; Toropova, M. A.; Simonova, T. P.; Zhuravlev, V. E.; Vorontsov, A. M. *Zh. Org. Khim.* **1989**, *25*, 156. (b) Nefedov, V. D.; Toropova, M. A.; Simonova, T. P.; Zhuravlev, V. E.; Vorontsov, A. M.; *Radiokhimiya* **1990**, *32*, 61.
- (191) Nefedov, V. D.; Toropova, M. A.; Simonova, T. P.; Avrorin, V. V.; Vorontsov, A. M. *Zh. Org. Khim.* **1990**, *26*, 1133.
- (192) Ford, G. P.; Schribner, J. D. *J. Am. Chem. Soc.* **1981**, *103*, 4281.